



PERFORMANCE OF SHADING DEVICE INSPIRED BY TRADITIONAL
HEJAZI HOUSES IN JEDDAH SAUDI ARABIA

By

Sara Adel Batterjee

Dissertation Submitted in Partial Fulfillment of
MSc in Environmental Design of Buildings

August 2010

The British University in Dubai

Supervisor

Dr. Abeer Al Janahi

Abstract

With the recent economic boom in Saudi Arabia many new high-rise buildings, residential compounds and social complexes are under construction. Designing these buildings without respect to the residents' social and religious needs creates a problem in the development toward globalization and acceptance of resulting urban change.

This research seeks to propose a solution through the development of a shading device inspired by an environmental control architectural element of window shading, found in traditional *Hejazi* architecture of Saudi Arabia called *al Roshan*, that provides the physically desirable amount of natural-lighting and maintains socially-accepted visual privacy.

Five shading device design cases were proposed, and different parameters manipulated and tested for natural-lighting lux levels using Ecotect and Radiance software.

The first design case succeeded in providing comfortable natural-lighting levels. In addition, the design's cooling efficiency, when calculated and compared with the traditional *Roshan* in the same tested room, provided comfortable natural-lighting levels for North, South and West directions. It was also the best approach for most eastern orientations, except during the early morning hours. As it succeeded in reducing 50 % of the cooling loads compared to the traditional *Roshan* design, the proposed shading device was shown to be an energy-efficient solution.

الخلاصة

تشهد المملكة العربية السعودية في السنوات الأخيرة طفرة اقتصادية هائلة أدت إلى تطور العمران من ناطحات سحاب ومجمعات سكنية و تجارية. يتم تنفيذ هذه المباني دون مراعاة لاحتياجات السكان الاجتماعية و الدينية مما يخلق مشكلة في التطوير نحو العولمة وتقبل المجتمع لهذا التطور العمراني.

يسعى هذا البحث إلى اقتراح حلول معمارية من خلال تطوير عنصر معماري للتظليل مستوحى من عنصر تظليل وجد في العمارة التقليدية الحجازية في المملكة العربية السعودية ويسمى الروشان والذي يوفر كمية الإضاءة الطبيعية المطلوبة مع المحافظة على الخصوصية البصرية المطلوبة اجتماعياً.

اقترحت الباحثة خمسة تصاميم مختلفة لعنصر التحليل المقترح بحيث يتم تغيير برمجياتها لاختبار مستويات الإضاءة الطبيعية مقاسة بوحدة اللوكس وذلك عن طريق برنامجي Radiance and Ecotect

نجح المقترح الأول لعنصر التظليل في توفير مستوى الإضاءة الطبيعية المطلوبة بالإضافة إلى ذلك قدم التصميم كفاءة عالية في توفير استهلاك الطاقة اللازمة للتبريد مقارنة باستهلاك الروشان التقليدي في نفس الغرفة المختبرة.

كما حقق المقترح الأول لعنصر التظليل أفضل النتائج في توفير الإضاءة الطبيعية اللازمة و توفير من استهلاك الطاقة اللازمة للتبريد عندما استخدم في الاتجاهات الشمالية والجنوبية والغربية إلا أنها حققت نتائج شبه جيدة للجهة الشرقية في معظم ساعات اليوم ماعدا الساعات الأولى من الصباح حيث أنها وفرت 50% من استهلاك الطاقة اللازمة للتبريد مقارنة باستهلاك الروشان التقليدي المختبر في نفس الاتجاه.

لقد أثبتت نتائج البحث أن التصميم المقترح يعتبر حلاً عصرياً لتوفير الإضاءة الطبيعية اللازمة مع مراعاة الخصوصية البصرية و توفير الطاقة المستهلكة للتبريد.

Acknowledgements

I wish to give my heartfelt thanks to God, who always guides me and inspires me to the best of what I wish.

I would also like to thank those who made this dissertation possible. Among them are my supervisor, Dr. Abeer Al Janahi, whose guidance, support, and patience enabled me to develop a greater passion and understanding for the subject. Likewise, I wish to thank Professor Bassam Abuhijleh for his valuable guidance and input.

I owe my deepest gratitude to Dr. Faisal Al-Shareef, who generously shared with me his insight and guided me to valuable references. I thank Dr. Majdi Hariri for the kindness and concern he showed me throughout this research. I am grateful to the staff of Al Batool Baroom as well as Bushra Jundi for their honest care and support. I am also eternally grateful to my sisters, Sulafa, Thuraya and Sundus, along with my daughter Yasmin, who have all spiritually and emotionally shared the work of this research with me. .

Finally, I am forever indebted to my parents, who taught me the importance of ambition and determination in striving to reach my goals. This success, as well as many of the other success in my life, I owe to them.

I dedicate this work to my husband, who never stopped believing in me and supporting me. Without you, Hasan, this research would not have seen light.

Abstract

Acknowledgement

Table of content

List of Figures

List of Tables

Chapter One: Introduction	1
1.1 Introduction	1
1.2 Aim and Objective of the Research	2
1.3 Thesis Structure	2
Chapter Two: Literature Review	4
2.1 Introduction	4
2.2 Natural Lighting in Architecture	4
2.2.1 Human Needs	5
2.2.2 Daylight Component	6
2.2.3 Investigation in Energy Efficiency calculations	14
2.3 Jeddah	15
2.3.1 Location and Climatic characteristic	15
2.3.2 Historical Background of <i>Hejazi</i> Architecture	18
2.3.3 <i>Hejazi</i> Town Planning	21
2.3.3.1 Components of <i>Hejazi</i> House	22
2.4 <i>Al Roshan</i> : The origin and meaning of the word <i>Roshan</i>	27
2.4.1 The Components of <i>Roshan</i> found in Jeddah	28
2.4.2 The dimension of <i>Roshan</i>	30
2.4.3 Development of <i>Roshan</i>	33
2.5 Privacy: A main function of traditional <i>Hejazi</i> architecture	35
2.5.1 Contemporary solutions of Privacy	36
2.6 Conclusion	38

Chapter Three: methodology	40
3.1 Introduction	40
3.2 Defining Research Parameters	40
3.2.1 Reconfiguring the traditional parameters	41
3.3 Research Design and Methodology	42
3.3.1 Experimental Scale modeling	43
3.3.2 Computer Simulations	46
3.3.3 Selecting the research methodology	47
3.4 Ecotect Software Review	48
3.4.1 The Use of Ecotect in The Research	48
3.5 Radiance Software Overview	48
3.6 Validity and reliability	48
Chapter Four: Experimental Investigation	52
4.1 Introduction	52
4.2 The Research Plan	52
4.2.1 Step One: Traditional house case study and modeling	53
4.2.2 Step Two: Modern house case study modeling	64
4.2.3 Step Three: Development of the successful case	77
4.2.4 Step Four	79
4.3 Conclusion	79
Chapter Five: Conclusion and Recommendation	81
5.1 Introduction	81
5.2 Efficient Natural Lighting Inspired by Tradition	82
5.2.1 The Design of the shading device and its Efficiency	82
5.2.1.1 Natural lighting	82
5.3 Energy efficiency	88
5.4 Conclusion	91
5.5 Recommendation	92
References	93

Appendices

Appendix (A) CD with Excel file

Appendix (B) CD with Excel file

Appendix (C) CD with Excel file

Appendix (D) CD with Excel file

Appendix (E) CD with Excel file

Appendix (F) CD with Excel file

Appendix (G) CD with Excel file

List of Figures

VII

Figure 2-1 Human needs served by lighting

Figure 2-2 SC, IRC and, ERC

Figure 2-3 The light process when it strikes a surface

Figure 2-4 Specular Reflectance and Transmittance

Figure 2-5 Diffuse Reflectance and Transmittance

Figure 2-6 Map of Jeddah

Figure 2-7 Monthly average temperatures/ daily Conditions

Figure 2-8 Prevailing wind frequency (Hrs)

Figure 2-9 Annual Incidents solar Radiation

Figure 2-10 British counsel building 1917

Figure 2-11 Street scenes 1916

Figure 2-12 *Hejazi* town street layout

Figure 2-13 Material and Construction process of the *Hejazi* house

Figure 2-14 Typical *Hejazi* house plan

Figure 2-15 Majlis interior view 1

Figure 2-16 Majlis interior view 2

Figure 2-17 Fixed louver *Roshan*

Figure 2-18 Shutters are hinged or slide vertically

Figure 2-19 Screens *Roshan*

Figure 2-20 Process of the *Roshan* construction

Figure 2-21 Dimensions of the *Roshan* details

Figure 2-22 Samples of wooden screens

Figure 2-23 Sample 1 of wooden screen blow up

Figure 2-24 Sample 2 of wooden screen blow up

Figure 2-25 Examples 1 of contemporary solution for visual privacy

Figure 2-26 Examples 2 of contemporary solution for visual privacy

Figure 3-1 The Megatron architectural model lux-meter

Figure 3-2 Model of second experiment

Figure 3-3 Measured and simulated indoor illuminance for sun-facing surface under non-overcast skies.

Figure 3-4 Measured and simulated indoor illuminance for sun-facing surface under non-overcast skies,

Figure 3-5 Comparison of case where opposing building obscures part of the sun and sky. Clear double low-E glazing.

Figure 4-1 Perspective view of traditional building generated from Ecotect

Figure 4-2 Traditional *Roshan* details as built on Ecotect

Figure 4-3 *Roshan-t* opening blow up

Figure 4-4 Traditional *Roshan* daylight reflection generated on Ecotect

Figure 4-5 Traditional *Roshan* grid analysis lux levels generated on Ecotect

Figure 4-6 Calculation wizards 1 of Ecotect

Figure 4-7 Perspective view of Sun position of traditional building on December at 12 p.m.

Figure 4-8 Plan view of sun position of traditional building on December at 9a.m.-12p.m.-3p.m.

Figure 4-9 Calculation wizards 2 of Ecotect

Figure 4-10 Exporting Ecotect file to Radiance

Figure 4-11 Radiance generated image

Figure 4-12 Radiance generated image with Lux levels

Figure 4-13 Proposed cases legend

Figure 4-14 Design details of case 1 as built on Ecotect

Figure 4-15 Case 1 opening blow up

Figure 4-16 Design details of case 2 as built on Ecotect

Figure 4-17 Case 2 opening blow up

Figure 4-18 Design details of case 3 as built on Ecotect

Figure 4-19 Case 3 opening blow up

Figure 4-20 Design details of case 4 as built on Ecotect

Figure 4-21 Case 4 and 5 opening blow up

Figure 4-22 Design details of case Five as built on Ecotect

Figure 5-1 *Roshan-t* Lux levels over four orientation (North/ East/ West/ South)

Figure 5-2 Case one Stainless steel double glazed low E aluminum frame lux levels over four orientations.

List of Tables

X

Table 2-1 IESNA Lux Level Guide

Table 2-2 the change of IRC depending on the reflectance of the surface

Table 2-3 Recommended Reflectances for Interior Surfaces of Residences

Table 4-1 The conducted tests based on the investigation plan

Table 4-2 Buildings Material Specifications as built on Ecotect

Table 4-3 *Roshan-t* Lux levels

Table 4-4 Indirect solar gain for *Roshan-t* on four orientations

Table 4-5 Glass specifications

Table 4-6 *Roshan-t* and *Roshan-p* tests schedule

Table 4-7 S-C1 Lux levels

Table 4-8 S-C2 Lux levels

Table 4-9 S-C3 Lux levels

Table 4-10 S-C4 Lux levels

Table 4-11 S-C5 Lux levels

Table 4-12 S-C1 Sum of Lux levels

Table 4-13 S-C1 Cooling loads

Table 4-14 C1 Lux levels over three orientations (North/ East/ West)

Table 5-1 A comparison of *Roshan-t* Lux levels over four orientation (North/ East/ West/ South)

Table 5-2 A comparison of case one stainless steel double glazed low E aluminum frame lux levels over four orientations.

Table 5-3 Cooling load required in Watt per hour for the 36m² tested room

Table 5-4 Glass types specifications

Figure 5-5 Reduction of cooling load in percentage

List of Equations

XI

Equation 2-1 Illuminance

Equation 2-2 Light reflection when the material is opaque

Equation 2-3 Light transmittance

Equation 2-4 Reflection of specular surface

Equation 2-5 Internal reflected component

Chapter One: Introduction

1.1 Introduction

Coming from an interior design background, our main concern is to provide comfortable interior environments. Architecture and interior designs are two practices that should not be separated when aiming to provide ultimate human needs solutions. Natural lighting design is one of the strategies that intersect between the architectural and interior setup. The drive of this research is to study a number of aspects in those two practices and understand the relationship between the shelter envelope and its effect on the interior spaces. When aiming to provide sustainable modern solutions it is advisable to go back to the traditional architecture of the meant locale and analyze the strategies in the built environment.

When searching for sustainable solution in natural lighting, the researcher needs to evaluate the current situation and its impact on the human living. According to (Winchip 2005) in the International Energy Outlook Report 2002, published by the Department of Energy's Energy Information Administration, by the year 2020 world energy consumption will reach up to 612 quadrillion Btu. The report claims Asia and Central and South America are the largest consumers. And their consumption will increase by 3.9% to 4.5% per year. According to the U. S. Environmental Protection Agency.

23% of the electricity consumed in buildings globally is used for generating artificial lighting. However 20% of the consumed electricity for air conditioning is used to regulate the heat generated by artificial lighting.

In addition, the International Association of Energy Efficient Lighting conducted a study on 38 countries, and revealed artificial lighting consumed more than 2000 TWh electricity and resulted in the production of 2900 million metric tons of carbon dioxide emissions (CO₂) per year worldwide. The study also noted that the highest artificial lighting demands are in the services and residential sectors.

It is clear from the above that artificial lighting accounts for a major portion of the energy consumption in many building types around the world. Therefore efficient artificial lighting systems should be taken in account for all the design and engineering sectors, and a special consideration should be given to natural lighting provision as a proposed solution to reduce the demanded energy requirements.

1.2 Aim and objective of the research

The main aim of this research is to develop a shading element to be implemented in modern residential architecture in Jeddah Saudi Arabia with the intention to provide the physically desirable amount of natural lighting and at the same time socially accepted visual privacy.

The shading device design parameters are inspired by an environmental control architectural element of window shading found in the traditional Hejazi architecture of Saudi Arabia called (Al Roshan).

In order to achieve the aim of the research, a number of objectives need to be accomplished:

- 1- To explore and identifying the current situation of Hejazi residential buildings in terms of natural lighting and visual privacy.
- 2- To understand through literature review the “Roshan” window shading as an architectural environmental control device used in Hejazi architecture.
- 3- To explore a natural lighting control device that is inspired by “Al Roshan” shading and designed using parametric methodology.
- 4- To carry out computer simulation experiment to compare between the traditional of “Roshan” shading device and the developed device in an attempt to validate the later.

1.3 Thesis structure

This research contains five chapters. Chapter one is an introduction of the topic, aims and objectives of the research, and structure of the study. This is followed, in chapter two, by a literature review of the main subjects of the research, those being as follows: the importance of natural lighting in architecture and its purpose for human beings; a situational and climatic overview of Jeddah; and the historical background of Jeddah accompanied by a data analysis of information collected on Jeddah in the areas of city planning, architectural elements and social aspects. In this chapter, special focus is given to the traditional *al Roshan* shading

element as it is the subject of this research. Chapter three focuses on the research methodology, examining the use of computer simulation as an acceptable tool for measuring expected outcomes. Chapter three also seeks to provide an overview of the Ecotect and Radiance software programs used in the computer simulation process. Chapter four explains the research's test plan, beginning with the input and structure of the experiment and followed by a display of the results and an analysis of the outcomes. Finally, in chapter five, the research is concluded and design recommendations are established for future studies.

Chapter Two: Literature Review

2.1 Introduction

In this chapter the researcher will provide an analysis of the main subject's background, beginning with the use of natural lighting in architecture and its main components, the city of Jeddah and its climatic characteristics, traditional *Hejazi* architectural history and its features, and, finally, an analysis of contemporary *Hejazi* architecture.

Understanding the physics of natural lighting in architectures will help the researcher to develop more advanced systems that can enhance natural lighting levels with reasonably controlled increase in the heat gain, as for the climatic characteristics of Hejazi region and Jeddah in specific, it is essential to analyze its location and climate, along with its traditional architecture and the way it was developed over the years. Ancient societies proved to be sustainable societies where they managed to survive in less developed environment, architectural components of these traditional buildings are formed to serve the needed functions in their living spaces. Researching in these qualities and analyzing it to benefit from the sustainability of their built environment will be discussed in details.

2.2 Natural lighting in architecture

The availability of natural lighting in residential interiors is crucial to the health and wellbeing of humans. Several studies in the past 20 years have revealed the effect of naturally lit interiors on the physiology, mood and behavior of the occupant (Kim and Kim 2010). Work productivity is also an important factor when comparing the benefits of naturally- lit over artificially-lit spaces. Through research surveys, many people working in naturally-lit environments were shown to experience less stress and fatigue, resulting in an increase in the quality of the work produced (Cheung, and Chung 2008). Of course, in general, lighting availability in any space is a basic human need in terms of visibility.

Availability of natural lighting in houses is very crucial for the house hold, due to the psychological and physical affects, especially on young children and the positive affect that it has on their wellbeing and growth. Keeping in mind that natural lighting in interior spaces should be well measured not to exceed comfort levels, which might lead negatively on the energy

required for cooling loads. Understanding the importance of providing comfortable natural lighting levels for human beings in the interiors is the motive of this research.

2.2.1 Human needs

The presence of light in the human environment is a basic human need. It is required in order to live a good life. The availability and quality of lighting may both directly affect a person's perception of his surroundings and influence one's emotional and physiological reactions. Visibility, or "the ability to extract information from the field of view" (Rea 2000, p. 10-1), is the primary reason humans need lighting.

Good lighting design requires knowledge of the needs humans have in respect to lighting and an understanding of energy efficiency both of which can then be used in the applications of the design.

The basic functions that is served by natural lighting availability in living spaces is displayed in figure 2-1, most crucial is the visibility to visual things and that can be served by natural or artificial lighting, others are, mood and atmosphere, visual comfort, aesthetic judgment, health, safety, and wellbeing, social communication, and task performance.

It was noticed in the *Hejazi* traditional architecture, that a special attention was given to provide natural lighting in interiors, that was displayed in the design of the *Roshan*, were it was a controlled source of light. Although the climate of the *Hejazi* region might discourage the people from providing windows and that is due to hot humid characteristics of the weather, hence the importance of natural lighting existence led to provide architectural solutions like the *Roshan*.

Figure 2-1 Human needs served by lighting, Rea, M. S. (2000)

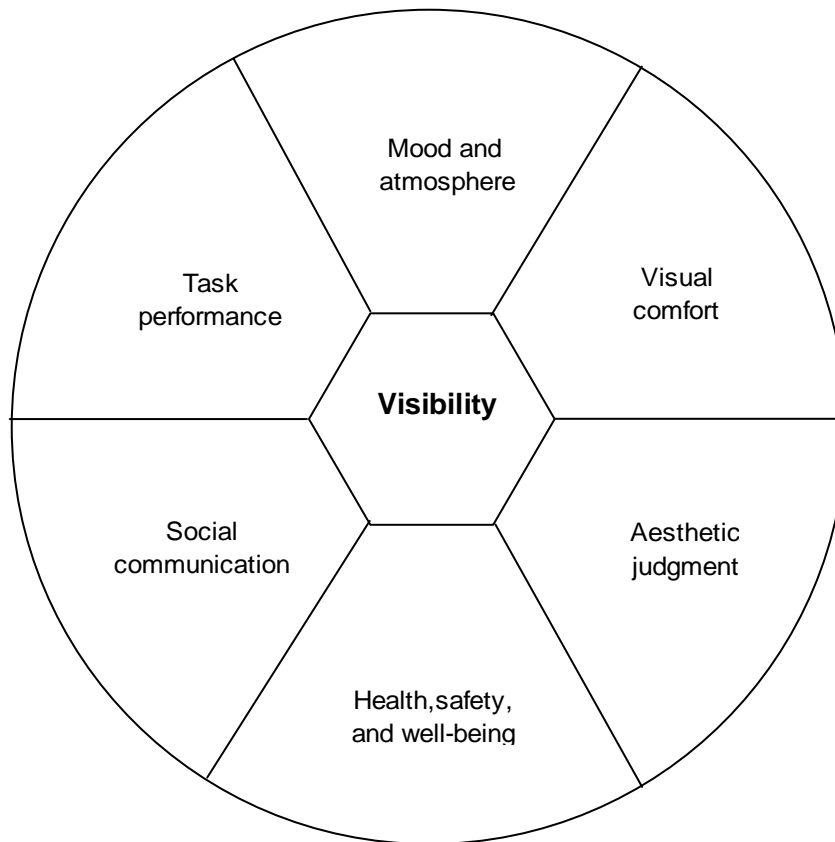

2.2.2 Daylight components

It is important to understand the nature of daylight, and the way it is reflected in interior spaces in order to properly evaluate the research process and outcomes.

One of the main objectives of this research is to measure the natural lighting in the tested room, there are two ways to measure the quantity of the available light in interior spaces, first is illuminance by lux levels, and the second daylight factor by percentage.

Based on a conducted experiment of a scaled model using Radiance and comparing it with an existing classroom, Li and Tsang (2005), noted that the daylight levels are more accurate than the daylight factor (DF).

Conventionally, the illuminance from natural sources is often determined in terms of DF with the calculations being based on the CIE overcast sky. However, daylight illuminances inside a room are not, in general, proportional to the external illuminance, but depend on the exact sky luminance distribution at that time. This is because a point in a room will receive direct light only from certain areas of the sky and the illuminance within a room is not equally sensitive to changes in the luminance of different parts of the sky. Interior daylight calculations using standard skies and DF would give poor estimates of actual illuminance (Li and Tsang 2005, p. 975).

Therefore the researcher decided to use natural lighting levels illuminance in lux, to be measured in a given point in interior spaces, which will lead to determining the suitability of the natural light controlling device, and the required energy load. It will be mentioned later in this research that daylight calculations will be measured at 35 cm high above the finished floor level, which is the lowest plane level available in any given room. At this height light reflections can be will be considered in the calculations accurately.

In residential interior space, many functions are conducted in the various rooms, in general the most room used by households is the living room. That is noticed especially in the Saudi culture, where the living room is considered to be the daily gathering area of the whole family, where each member can work on a separate function. Table 2-1 displays different functions are utilized in residential spaces and the required international standards of lux levels for each function, knowing these levels is very crucial for this study, as it will be the reference in which will determine the suitability of the provided light level in the living space.

Table 2-1 IESNA Lux Level Guide, Rea, M. S. (2000)

Residences	(lux) Horizontal	(lux) Vertical
General lighting	50	
Conversation, relaxation, and entertainment	30	30
Passage areas (circulation)	30	30
Specific visual tasks		
Dining ✓	50	
Grooming		
Makeup and shaving	300	50
Dressing evaluation (mirror)	300	50
Handcrafts and hobbies		
Ordinary tasks (e.g. crafts) ✓	300	50
Difficult tasks (e.g. sewing) ✓	500	100
Critical tasks (e.g. workbench)	1000	300
Easel hobbies ✓		300
Ironing	300	
Kitchen counter		
Critical seeing (e.g. cutting)	500	100
General	300	50
Kitchen range		
Difficult seeing (e.g. cooking)	500	100
Kitchen sink		
Difficult seeing	500	100
Noncritical (clean up) ✓	300	50
Laundry	300	30
Music study (piano, organ) ✓	300	50
Reading		
In a chair (casual) ✓	300	50
In a chair (serious) ✓	500	100
In bed (casual) ✓	300	50

The highlighted functions are the most conducted in living rooms, the range of lux levels of the selected functions are between (50- 500 lux) which will be the targeted range to be achieved in the tested room in this research, and will be called *Comfortable natural lighting levels*.

Basic physics of natural light existence in interiors will be discussed briefly in this section, in order for the researcher to properly create solutions, and enhance the natural lighting availability in the interiors.

Illuminance is defined as “the light reaching the surface” (Rea 2000, p. 9-35). The light reaching the surface is the result of surrounding surface inter-reflections. There are two types of illuminance referred to in calculations. The first is the light coming directly from the source. The second is the light coming from a secondary source, which is luminous by reflection. Both calculations determine how much light is reaching the surface, either on average or as the light-level of a given point on a measured surface. The calculation is as follows:

$$E = F / A$$

Where

E = illuminance of a surface, lm/m² or lux

F = luminous flux incident on the surface, lumen

A = area of the surface, m²

Equation 2-1 illuminance, (Rea 2000, p. 9-35).

There are two types of emitters in illuminance calculations, diffused and non-diffused. In this research, the calculations are based solely on daylight, which is considered to have a diffused emitter, namely the light coming from the sky vault.

According to Baker and Steemers (2002), the following three main components of daylight affect the illumination of interior spaces: the light coming directly from the sky, known as the sky component (SC); the light coming from external surfaces, like trees and building, which are referred to as externally reflected components (ERC); and the light that is reflected from internal surfaces, known as the internal reflected component (IRC).

The ERC mainly depends on the density of the buildings and objects situated around the building representing the measured point. It is usually found at a point lower than the sky component and closer to the horizontally. This type of light reflection penetrates deeper into a given room but is generally weaker because of the collective light absorption made by other building surfaces.

Conversely, the IRC is a measured point of light that has been reflected by another surface within a given room. The reflecting surface is originally illuminated by either (SC) or (ERC), which is then reflected into the interior. For example, if light is reflected from beneath the surface of a plane, then it must be reflected for a second time off of the ceiling or a wall surface in order to illuminate the surface of another object in the same room.

Figure 2-2 SC, IRC and, ERC, Baker, N. and Steemers, K. (2002)

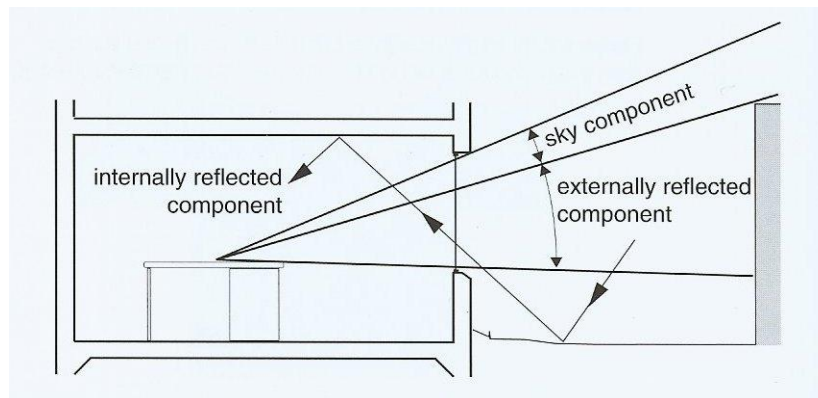

In this research, the use of devices and materials will be used in an attempt to redirect light onto walls and ceilings, instead of having direct sunlight on the interior planes based on the recent natural-lighting design recommendations.

When light falls onto the interior surfaces, the following three light processes are likely to occur: light will be reflected, light will be transmitted, and/or some energy will be absorbed in either of the two aforementioned processes.

When a given material is opaque, the following equation can be applied:

$$R = (1 - a)$$

Equation 2-2 Light reflection when the material is opaque, Baker and Steemers (2002)

In the preceding equation, R represents "...the ratio of the reflected energy to the incident energy ... called the reflectance," while a represents "the ratio of absorbed energy to the incident energy ... called the absorptance" (Baker and Steemers 2002, p.89).

If the reflectance of perfect black is 0 while that of perfect white is 1, the reflectance of all other material will be between 0 and 1.

The calculation for transparent materials is as follows:

$$R = (1 - a - T)$$

Equation 2-3 Light transmittance, Baker and Steemers (2002)

In this equation, R represents “...the ratio of the reflected energy to incident energy ... called the reflectance,” however, a is “...the ratio of absorbed energy to incident energy ... called the absorptance.” On the other hand, T refers to “...the ratio of transmitted energy to incident energy called the transmittance” (Baker and Steemers 2002, p.89).

As mentioned previously, most materials are either opaque or transparent, though many of the items studied in the selected area have opaque properties, such as furniture. Transparent properties can be found in items such as windows. Consequently, the researcher decided to list the basic physics of light movement in the interior spaces.

Figure 2-3 The light process when it strikes a surface, Baker, N. and Steemers, K. (2002)

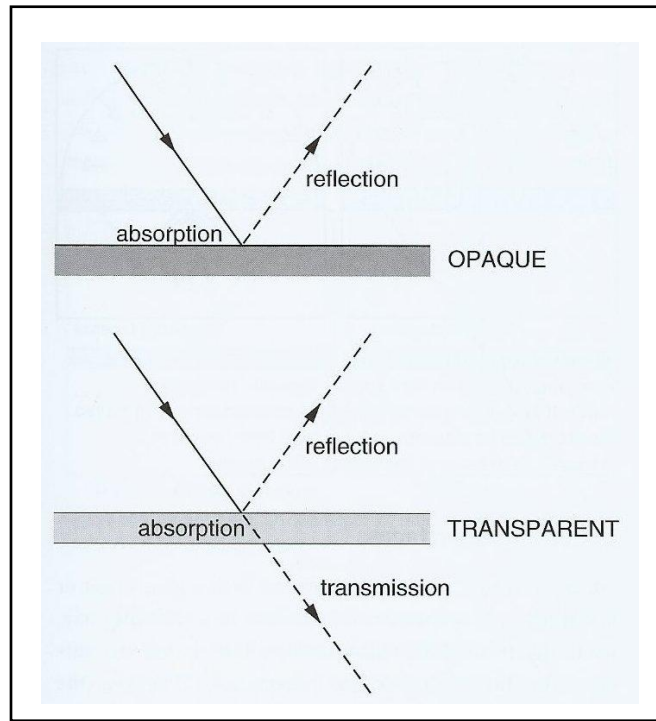

When an opaque surface gives a perfect reflection like a mirror, it is called a specular surface, and the equation for the reflection will be as follows:

$$\text{Angle of incidence } (I) = \text{angle of reflection } (r)$$

Equation 2-4 Reflection of specular surface, Baker and Steemers (2002)

When a transparent surface is referred to as being specular, it means that it transmits a direct beam of undiffused light; it can be defined as follows:

The reflectance is the ratio of reflected light flux to incident light flux.

Transmittance is defined as the ratio of the transmitted flux to incident flux.

Figure 2-4 Specular Reflectance and Transmittance, Baker, N. and Steemers, K. (2002)

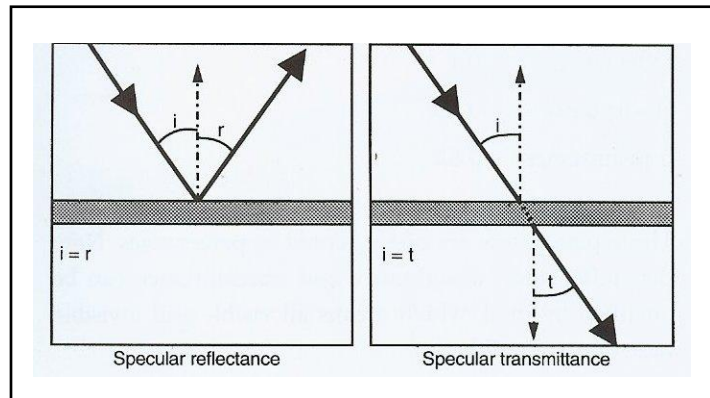

Of course, both opaque and transparent materials can diffuse. When this is the case, the reflected, or transmitted, light flux is distributed in all directions.

“Repeated exchange of light by multiple reflections is called inter-reflection” and surfaces become luminous through this phenomenon (Rea 2000, p. 10-1).

A variety of interior materials can diffuse light at varying levels depending on the material’s surface properties, as mentioned above. It is important, however, to note that the color of the surface also affects the amount of surface diffusion that occurs; the brighter the surface is, the higher the rate at which it diffuses light. following this phenomena you will be using different materials with different properties will be tested in this research for the purpose of enhancing the

natural lighting levels. For example stainless steel is a bright with smooth high reflective surface material, where it can reflect back a larger about of light.

Figure 2-5 Diffuse Reflectance and Transmittance, Baker, N. and Steemers, K. (2002)

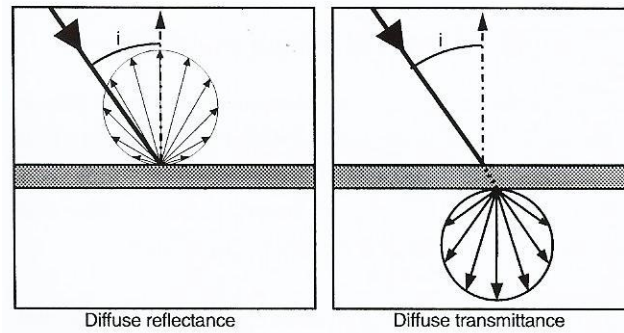

Reflectance of interior surfaces can influence the depth of light penetration into a room. It is calculated as follows:

$$IRC = R \cdot F / S (1 - R)$$

Here, "S" is the total area of the surfaces of the room.

"R" is the average reflectance of the surface

"F" is the luminous flux (lumens) entering the room.

Equation 2-5 Internal reflected component, Baker and Steemers (2002)

Table 2-2 the change of IRC depending on the reflectance of the surface, Baker, N. and Steemers, K. (2002)

Average Reflectance of surfaces	IRC (lux)
0.1	52
0.3	200
0.5	466
0.7	1087

Table 2-3 Recommended Reflectances for Interior Surfaces of Residences, Rea, M. S. (2000)

Surface	Reflectance (%)	Approximate munsell value
Ceiling, curtain and drapery	60-90	8 and above
Treatment on large wall areas	35-60	6.5-8
Walls	35-60*	6.5-8
Floors	15-35*	4.0-6.5

*In areas where lighting for specific visual tasks takes precedence over lighting for the environment, the minimum reflectance should be 40% for walls, 25% for floors

2.2.3 Investigation in Energy Efficiency calculations

This research focuses on providing sustainable natural lighting solutions; therefore, it is necessary to measure the impact of the proposed solution on the solar radiation and energy consumption loads in the tested room. through Ecotect software the researcher will test the indirect solar gain or energy consumption as a second step after evaluating the comfortable lux levels, when the successful cases are determined then the case with less energy consumption will be selected as the best approach. Meaning it will provide the required natural lighting levels while it is consuming the least energy of all proposed cases. More details will be explained in chapter three.

Cooling Loads

The cooling load for a certain space is the required energy in watts per hour to cool that space in order for it to reach human comfort level. In Ecotect, this temperature is set to be between 18 -26 C°

Solar Gain

According to Ecotect, the orientation of windows within a model will determine when in the day solar gains occur within a given zone. Obviously, east-facing windows will let in more early morning radiation whilst west-facing windows will let in more mid-late afternoon radiation.

As for indirect solar gain, it is the heat transmitted indirectly to a space through the thermal mass of the adjacent building elements. The heat is stored in the building's thermal mass by the convection and conduction of solar radiation.

In this research, the main concern is with the required cooling load for the selected testing room using natural lighting only, artificial lighting is not within the tested parameters of this research due to the limited time of this research. and to focus on the main objective of this study, which is maximizing the use of natural lighting to reduce the use of artificial lighting while considered the consumption of the cooling load needed. Therefore calculating the energy required to cool the testing room using different approaches will aid in determining which design is the most efficient.

2.3 Jeddah

2.3.1 Location and Climatic characteristic

The city of Jeddah is located along the western coast of the Kingdom of Saudi Arabia, centrally located in a region referred to as "*Hijaz*," which includes two other main cities, Makkah and Madina. Located east of the Red Sea, Jeddah is precisely located at 21°29'31"N 39°11'24"E. refer to figure 2-6

Figure 2-6 Map of Jeddah

(Source: http://upload.wikimedia.org/wikipedia/commons/8/88/Jeddah_Saudi_Arabia_locator_map.png)



Jeddah is considered the economic and tourism capital of the country and is the second largest city after Riyadh. It has a very hot and humid climate. The highest temperatures are found in July and August, with an average daytime temperature of 37°C . The coolest months of the year are January through March, with a daytime average of 29°C as displayed in figure 2-7. Relative humidity reaches an annual high of 100% and an annual low of 40%. The prevailing wind current moves mainly north and northwest, with a majority of the wind coming from the Red Sea refer to figure 2-8.

Figure 2-7 Monthly Average Temperatures/ Daily Conditions

(Source: Ecotect weather tool)

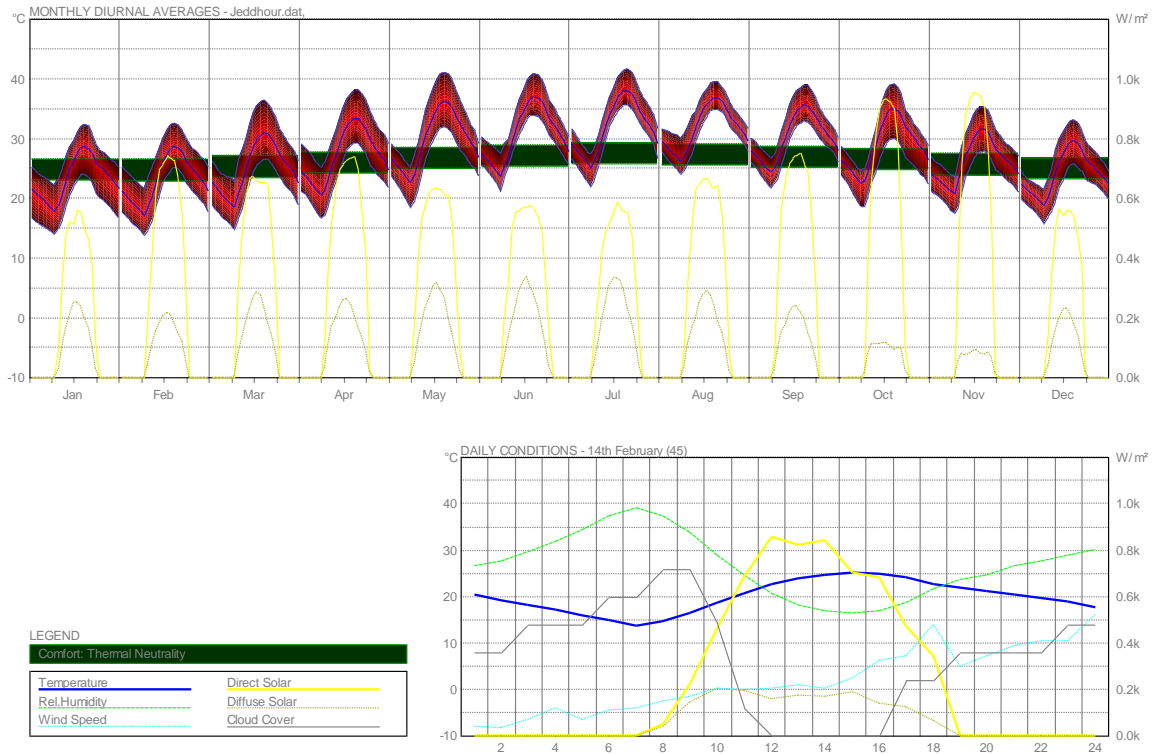

Figure 2-8 Prevailing Wind Frequency (Hrs)

(Source: Ecotect weather tool)

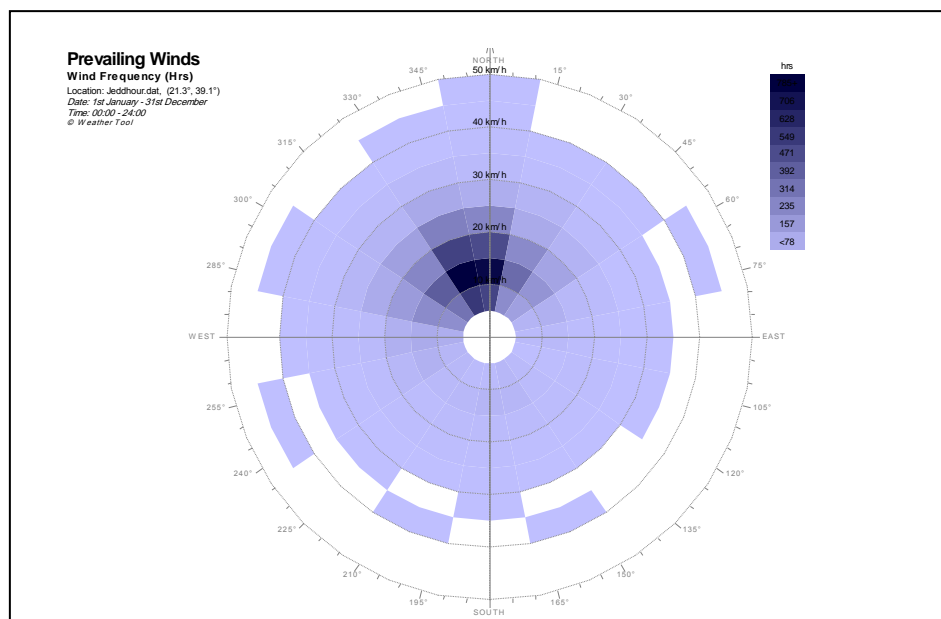
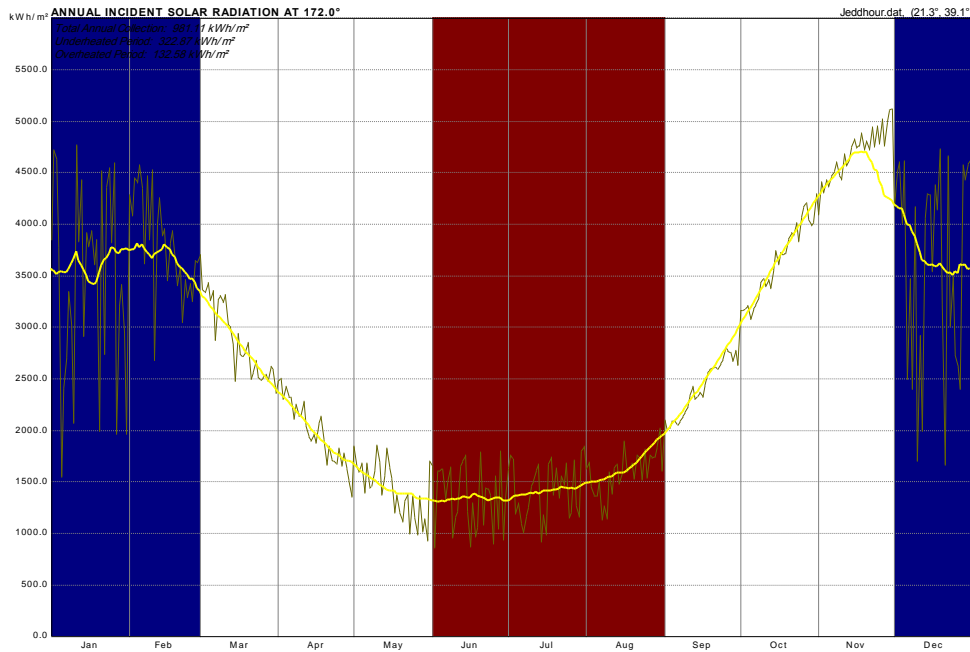

Figure 2-9 Annual Incidents Solar Radiation

(Source: Ecotect weather tool)



2.2.2 Historical background of Hejazi Architecture

The port of Jeddah was established 3000 years ago, during the pre-Islamic period, when the land was used as a trade port between Yemen and Egypt. Later, during the early Islamic period, and specifically during the caliphate of Uthman Bin Affan (AD 644-56), a historical transformation of the city occurred as it became the official sea and land entrance for pilgrims to the holy city of Makkah. In addition, the city also possesses an important strategic location. Being centrally positioned between three continents: Asia, Africa and Europe, it easily became a center for international trading. These two factors greatly influenced the traditional architecture of the *Hijaz* region.

The first ancient architectural structures found in Jeddah were the palaces of the Persians, who once lived in Jeddah and controlled trade between the *Hijaz*, Yemen, and Egypt between 975-94 CE. Roughly two-hundred years later in 1183 CE, Ibn Jubayr, traveling from Spain to Makkah on pilgrimage, visited Jeddah and mentioned in his writings that the homes, which he referred to as “the *khans*,” were built of stone and clay with reed structures forming the upper chambers. These reed structures were designed to release heat at night.

In the thirteenth century CE, Jeddah was revived under the Mamluki Empire, which included Egypt, Syria and the *Hejaz*. Ludovico Di Varthema, an Italian soldier-adventurer, described the beauty of Jeddah when mentioning how the houses rose from the edge of the water and how the sea could come right up to them. When the Mamluks were defeated by the Ottomans in 1517CE, the *Hijaz* passed to the Turks, and Jeddah continued as a port for Makkah.

According to (King 1998) From the description of a French voyager in 1700CE, it can be noted that the “*khans*” were made of coral stone and reached approximately three stories high; they were constructed around a central, open courtyard. Although the houses designed with central courtyards were not popular in Jeddah, they were seen in other *Hijazi* cities, like Mecca, that share the same, hot, arid climate.

By the beginning of 1800CE, the houses of Jeddah were described as having geometric ornamentation carved into the coral stone, a laborious yet enduring decoration. Each story of the home contained windows and wooden window screens. Some had bow windows, an exhibition of skilled craftsmanship. It is believed that the wood used in the window screens, *al Roshan*, was imported from East India or from the Mediterranean through Egypt and was crafted by local skilled carpenters from Jeddah.

Figure 2-10 British Counsel Building 1917

Figure 2-11 Street Scene 1916

(Source: <http://www.skyscrapercity.com/showthread.php?t=489776>)

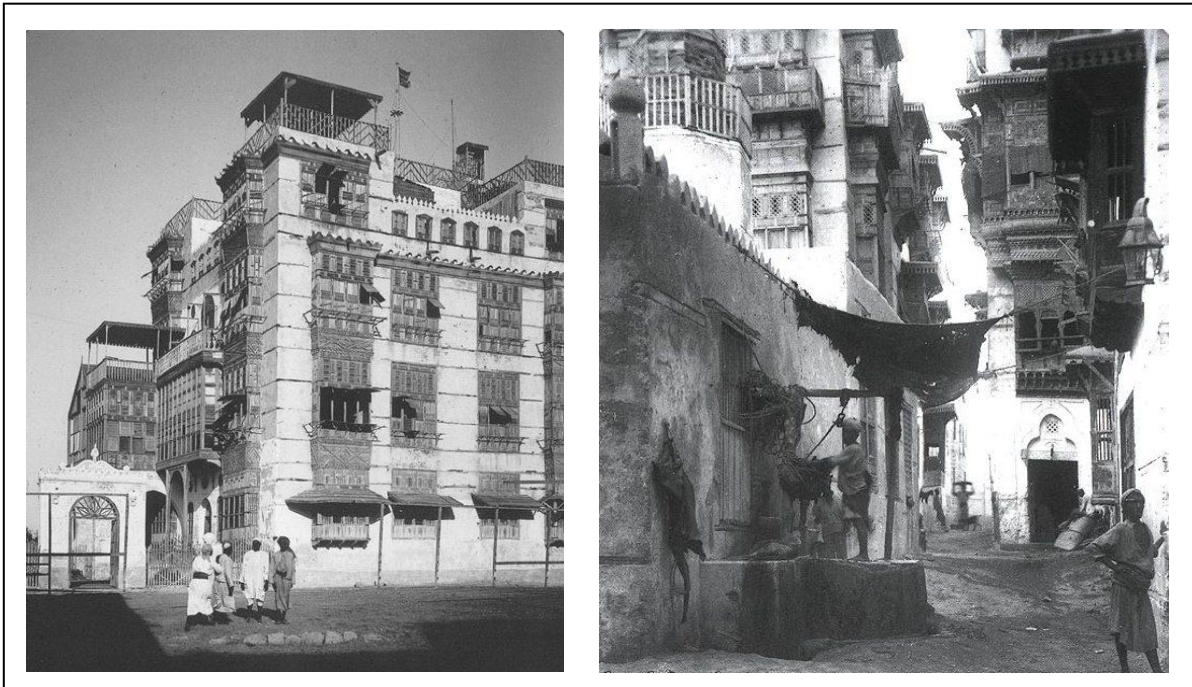

The hot and humid climate necessitated the use of a durable wood for the construction of the *al Roshan* shades. Teak wood was chosen specifically for this reason. The high cost of importing large quantities from India and the Mediterranean meant that teak *Roshan* served as an indication of the homeowner's high social status.

Coral blocks and mud mortar, described as the principal building material since the thirteenth century, were taken from Manaqabi Bay, which was located in the northern part of Jeddah. Teak wood was also used in home construction to support the gaps between the coral blocks often found in homes. The wood served to prevent the collapse of the walls, which might become weakened due to the high level of humidity and salinity in the air as well as the dampness of the soil. A thick coat of lime plaster was used on the exterior and interior surfaces to serve as yet another reinforcement of the building. It is also worth mentioning that the Kabaa in Makkah was also built in a similar fashion in 608CE, some seven-hundred years earlier.

In all, traditional *Hejazi* architecture has been influenced by many cultural influences over the centuries, though many historians consider the influence of Turkish and Egyptian culture to be

the most significant, knowing the origins of the *Roshan* is important for the research, first to direct the researcher where to investigate, second to understand the development process, based on the cultural background.

2.2.3 Hejazi Town Planning

The layout of the *Hejazi* town was comprised of two distinct urban areas: the commercial area, which was the central point of the town, and the residential area, which extends radially around the commercial market place.

In the case of Jeddah, the hierarchal distribution of streets began from the coastal line with the width of each street measuring 14 meters. They were designed to be wide enough to carry two loaded horse carriages. As the streets moved inwards, towards the city center, they narrowed down to irregular alleys measuring about two meters in width. It was these alleys that ultimately reached the residential area. Streets between the houses in the residential areas were small walkways and used mainly for pedestrians. The width was measured by the ability of the house owner to swing open doors and windows freely. These lanes were so narrow that the cantilevered wooden balconies of some houses were close enough that it was easy for women to hold a group discussion, each sitting behind her own *Roshan* without being seen from the outside.

Of course, privacy for woman in the *Hejazi* culture, in particular, and in Islamic societies, in general, was a very important factor influencing local architectural design. It is the duty of the Muslim woman to wear modest clothing and to not reveal certain parts of her body to men who are not related to her. Therefore, the traditional architecture of houses was built to fulfill both religious and cultural needs. The *Roshan* itself provides a good example of the unification of both design and function. Women could easily look out into the street, observing others and even interacting with them, without themselves being seen.

Figure 2-12 Hejazi Town Street Layout, Al-Shareef, F. M. (1996)



2.2.3.1 Components of the *Hejazi* house

The main body of the *Hejazi* house was made of coral stone blocks reinforced with horizontal poles of teak wood and covered with a thick coat of lime plaster to protect it from the damp air. The structure was cubical in shape and extended vertically in order to maximize the natural ventilation of the house.

Figure 2-13 Material and Construction Process of the Hejazi house, Author retrieved



Wooden elements like doors and windows were attached to the main structure. These elements were kept in their original color while the interior and exterior walls were plastered in white. The majority of the houses in the *Hejaz* had multiple floors. In Jeddah, buildings with two to five floors were common. The total area of most homes was between 200-500 m² (al Sharif 1996).

Description of typical Jeddah *Hejazi* houses

Figure 2-14 Typical Hejazi house plan, Jomah, H. A. S. (1992)

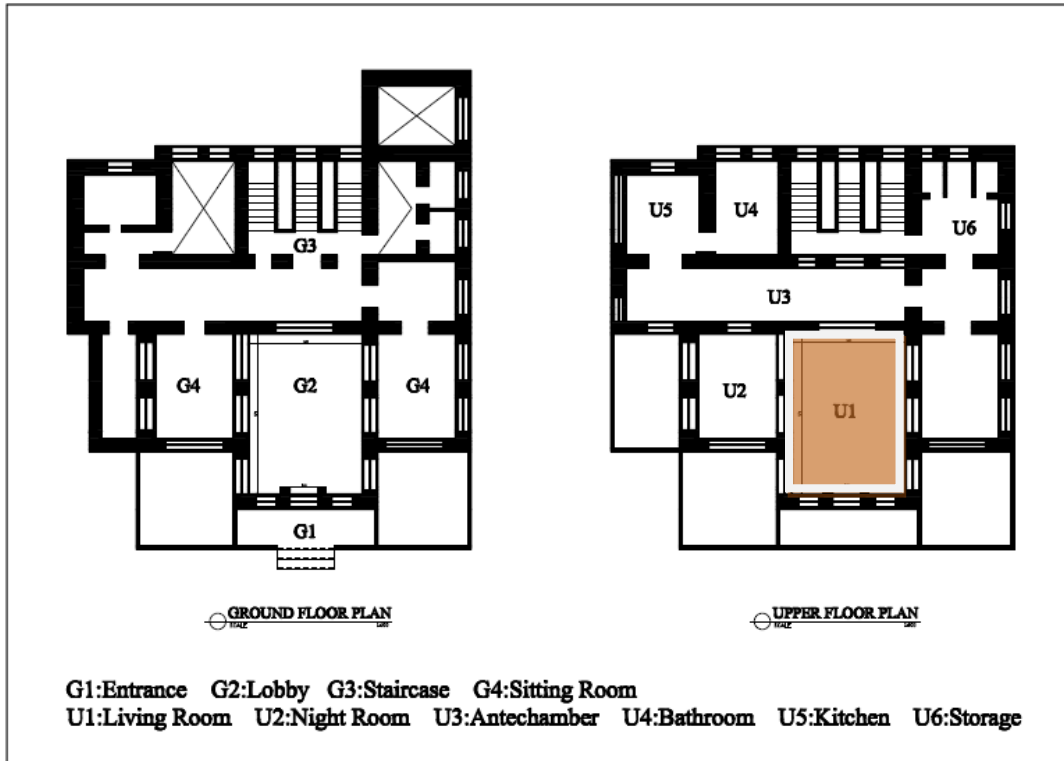

As illustrated in figure 2.14 and according to (Jomah 1992), the typical Jeddah house consisted of eight main areas spread out over the ground floor and the upper floors.

The main entrance (see area G1 of Figure 2-14) was located on the ground floor. This was the entrance generally used by male family members and house guests. The side entrance (not shown in Figure 2-14) was designated for females to ensure their privacy. In order to maintain even greater privacy for women once within the home, a separate staircase was also provided for the male guests in some cases.

The main entrance led directly into the lobby (area G2 of Figure 2-14). This area acted as a buffer zone between the public and private spaces of the house. It also functioned to prevent dirt and dust from entering interior spaces and enhanced the circulation of natural ventilation.

The sitting room(s) (area G4 of Figure 2-14) was also located on the ground floor. This area was mainly reserved for guests but could have other functions such as that of a business office, a casual reception area for men, a guest bedroom, a servant's quarter, a storage room, or an afternoon family resting area. This space usually had one or two *Roshan* window shades overlooking the street. As Jomah (1996) points out, the deeper and more elevated the space is within the home, the more private it becomes. Given that the sitting room was located on the ground floor and visible directly from the street, it was considered a semi-private space reserved for men.

The two floors were connected by an inner staircase (area G3 of Figure 2-14). This staircase was often placed at the far end of the house. If there was only one staircase present for use by both men and women, it would be screened by a corridor.

The upper floor(s) contained the living room, or *majlis* highlighted (area U1 of Figure 2-14). This was the largest room in the house with the largest *Roshan*. It could serve as a family's own suite during the hot summer season and also function as a sitting area for family members, relatives, and close friends. The living room was often located in the main façade of the house as it was one of the wider rooms and, therefore, let in natural breezes from outside. In order to create suitable room temperatures in summer and winter seasons, *Roshan* could be constructed facing north and south. As Jeddah lacked wind catchers like those found Egyptian cities at the time, windows were oriented towards the north in the summer season when the sun should be avoided and toward the south during the winter to direct the sun into the interior for passive heating. The Majlis or the living room in the first floor as mentioned previously is selected to be the tested area of this research due to two reasons: 1- Most important room in the house, where multiple functions are conducted there. 2- Contains the largest *Roshan* in the typical *Hejazi* Jeddah houses.

Figure 2-15 Majlis Interior View 1, Hazmi *et al* (2007)

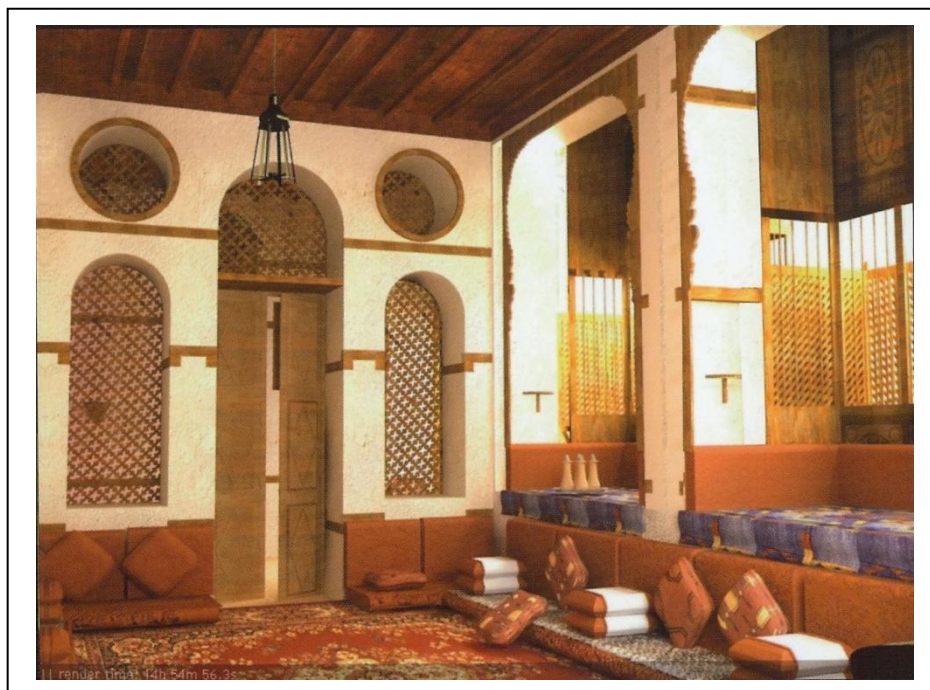
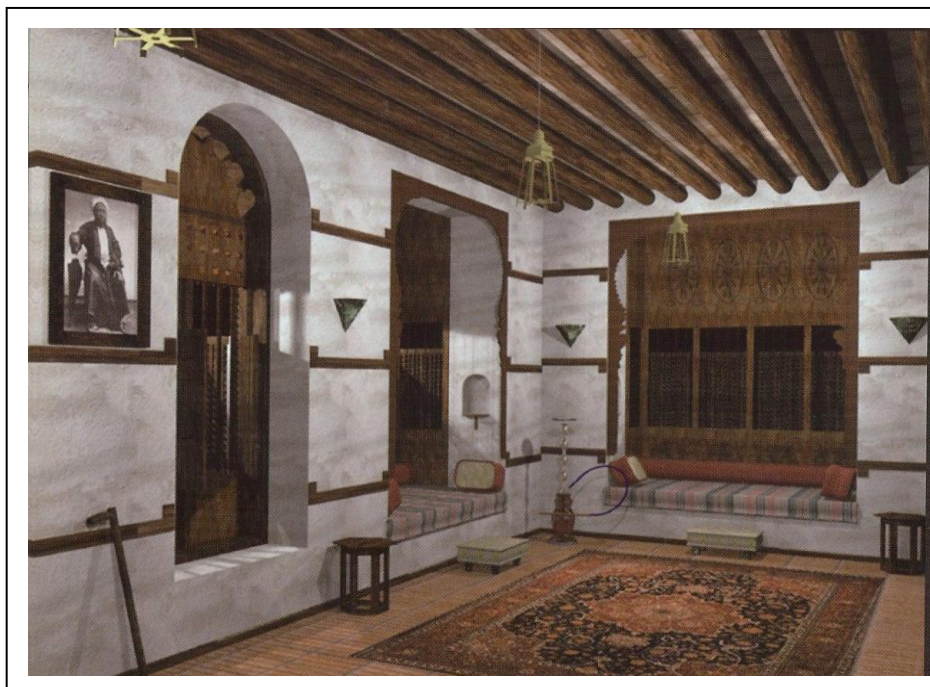

Figure 2-16 Majlis Interior View 2, Hazmi *et al* (2007)



Located next to the *majlis* was the night room (area U2 of Figure 2-14). It usually opened to the terrace and was used as a sleeping, dining and general living area by family members in the summer season.

The antechamber (area U3 of Figure 2-14) was located between the sitting room and the rear room and often served as a reception area for those rooms. It usually contained clothing and jewelry along with cupboards. It functioned as both a dining area and an entertainment room for women and children.

The bathroom (area U4 of Figure 2-14) was a small room equipped with a stone basin and tap.

The kitchen (area U5 of Figure 2-14) was equipped with a coal oven made from stone along with storage compartments for food and utensils.

Large furniture, like beds, and bedding was kept in the storage area (area U6 of Figure 2-14).

4.2 Al Roshan: The origin and meaning of the word *Roshan*

According to Maurice Tamiser and based on (king 1998), when he was accompanying Mohammed Ali Pasha's army in 1834, he was impressed by the buildings of Jeddah. He noted, "The doors and wooden screens of some houses were of an elegance of carving that was unrivalled elsewhere in Arabia. Furnishings and ceilings were in wood, painted and sculptured in a manner that reminded him of medieval work in Europe."(king 1998, pp.)

As Greenlaw (1976, p. 21) stated, "The distinguishing external features of the old houses of the Red Sea and some other Islamic and Indian styles are a large casement-windows jutting-out into the street to catch the slightest passing breeze. In Egypt they were called *mashrabiya*s, but in Suakin and Jeddah they were known as *roshans*."

The *Roshan*, or *mashrabiya*, is the wooden lattice work structure that is projected off a wide opening in facades of houses. It captures breezes from three directions and controls the penetration of daylight to the interior of the houses.

The word *Roshan* is derived from the Indian word "*rushaandan*" meaning the source of light or clerestory windows near the ceiling. The word "*rushaandan*" is constructed of two parts: "*rowshani*" meaning "light" and "*dan*" meaning "giver" (Al Shareef 1996; Al Jofi 1995).

According to (Hariri 1991), *Roshan* is originally an Arabic word derived from “*rawshun*,” meaning vent or whole in the wall.

(Hariri 1991) also claims that the word “*mashrabiya*” is related to *mashrabah* and *mashrobah* in Arabic. In Islamic literature, it is mentioned that the Prophet Mohammed, peace and blessing be upon him, used these terms to refer to a normal room or an elevated room. He also used the word “*yashra-eab*” as a verb meaning “extending his vision to overlook.”

(Al Sharif 1996) says that Fathy stated the word “*mashrabiya*” is derived from an Arabic word meaning “drink,” thus referring to “the place of drinking.” This is because it was in the *roshan* that water jars were situated so that the water would be cooled by the movement of air through the wooden lattice openings.

Although there are many sources of the origins of the word *Roshan*, But In this research, the word “*Roshan*” will be used as it is commonly used in Jeddah and the *Hejaz* as “a source of light.”

2.4.1 The components of Roshan found in Jeddah

According to Hariri (1991), there are two types of *Roshan* found in Jeddah. The first type is the *Roshan* that covers a single opening in a room. The second type is a *Roshan* that extends vertically, beginning from the top of a building to the bottom of the ground floor and covering multiple openings.

Both types of *Roshan* are comprised of three main parts, referred to as the top, the bottom, and the central, respectively. The top part consists of the crown, which shades the middle part of *al Roshan*. Under the crown is an upper belt comprised of wooden panels and usually containing geometrical or floral patterns. The bottom section of the *Roshan* contains a lower wooden belt, which is wider than the upper belt. This lower belt acts as a support for the entire *Roshan*, and from it, wooden timbers are imbedded into the structure of the building and covered with decorative wooden panels. The central part is made up of two sections that are divided vertically into three to five bays. These bays could be shutters, louvers or screens. Refer to Figure (2-17/ 2-18/ 2-19)

There are two types of shutters found in the central part of *Roshan*. One type is divided horizontally into two unequal parts. The upper part is larger than the lower one and is hinged

from the top while the bottom section is hinged from beneath. Both parts swing outwards when opened. The larger top shutter creates extra shade while the bottom one is supported with brackets to create a ledge (Greenlaw 1976) (refer to Figure 2-18). The other type of shutter is also divided horizontally; however, it slides vertically, upwards and downwards, along tracks (Al-Jofi 1995) (refer to Figure 2-18).

The louvers found in *Roshan* are essentially adjustable, horizontal, wooden slats. The screens are either fixed or moveable. They are often decorative and come in many forms and sizes. (refer to Figure 2-19).

Figure 2-17 Fixed louver Roshan **Figure 2-18** Shutters are hinged or slide vertically, Al-Jofi, E. K. E. (1995)

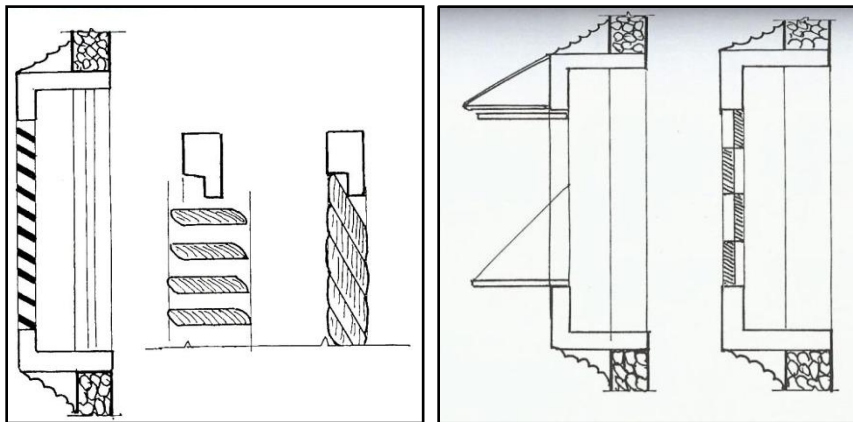
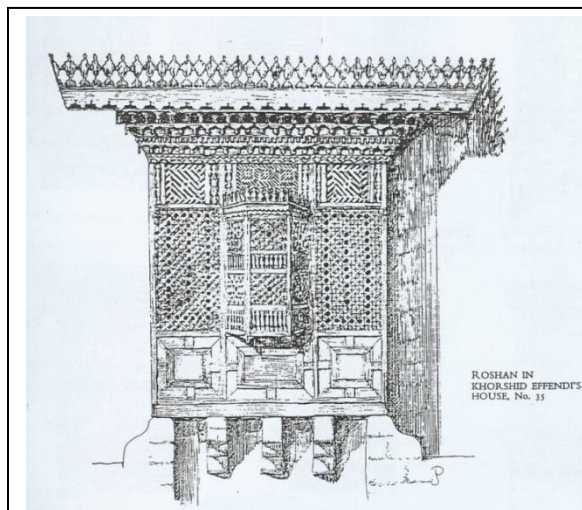
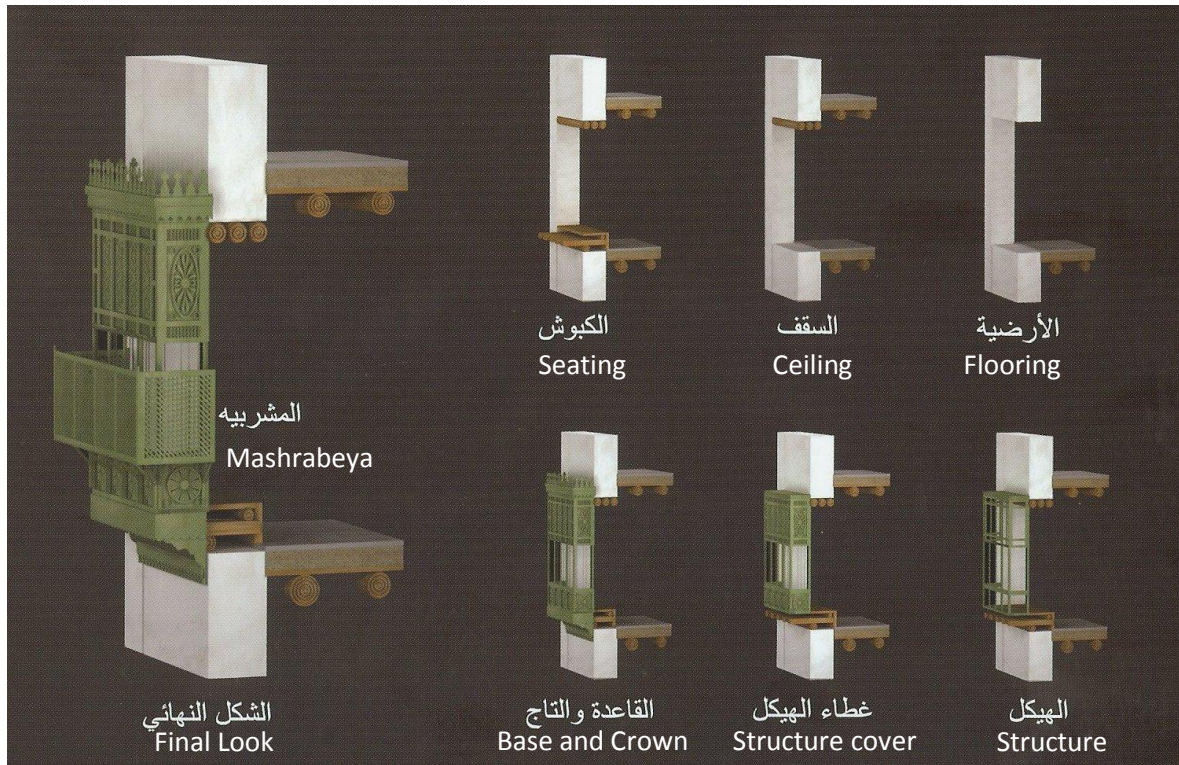

Figure 2-19 Screens Roshan, Greenlaw, J. P. (1976)



The Researcher was inspired by those three types of Roshan, which will be explained later in chapter four.

Figure 2-20 Process of the Roshan Construction, Hazmi *et al* (2007)



2.4.2 The dimensions of Roshan

Roshan come in many sizes and designs. (Greenlaw 1976) illustrated some of Jeddah's *Roshan* and stated that their sizes are comparable to the dimensions of the human body. The width is about 2.40 meters to accommodate a person lying down. The height is usually 3 meters, which is similar to the height of the room. It is projected 60 centimeters from the exterior of the building, adding 120- 140cm to the interior of the room when the thickness of the exterior wall (80cm) is included in the measurement. Ashraf Salloum, according to Al-Jofi (), has listed approximately the same dimensions for the *Roshan* in Jeddah.

Figure 2-21 Dimensions of the Roshan Details, Wzira, Y.(1999)

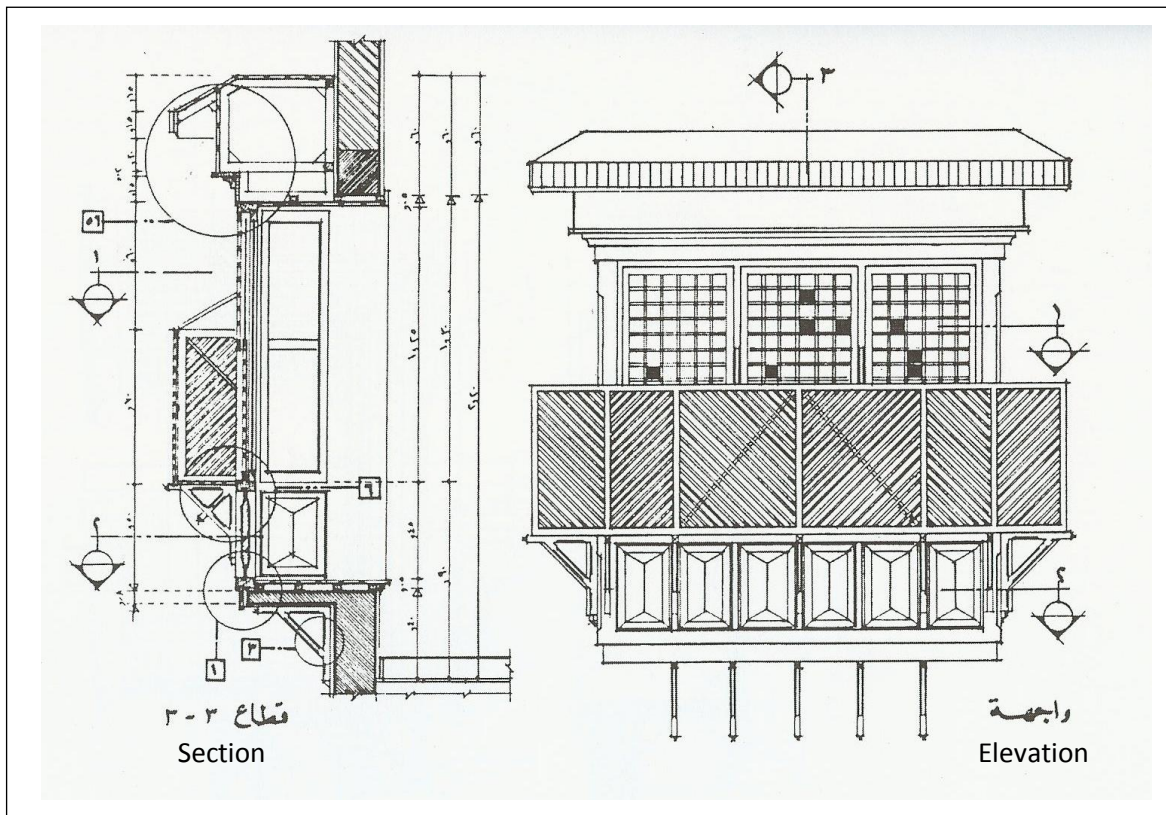

It is also worth mentioning another method of window treatment which was used in *Hejazi* architecture called a “*shish*,” meaning “screen panels.” Unlike *Roshan*, these wooden screens had no projection, though they served a similar function as the *Roshan*. However, they were less expensive and, therefore, the possessor of *shishes* was considered as holding a lower social status. The lower cost of *shishes* was due to the lower quality of craftsmanship with which they were designed. They were found in the houses of average-income families. (refer to figure 2-22/ 2-23/ 2-24)

There were two types of *shishes*. The first type of *shishes* were fixed screens, which often had many geometrical patterns. The second type were movable or fixed horizontal wooden louvers, often consisting of twelve units, each of which could be manually adjusted to in order to control penetration of daylight.

Figure 2-22 Samples of wooden screens, Greenlaw, J. P. (1976)

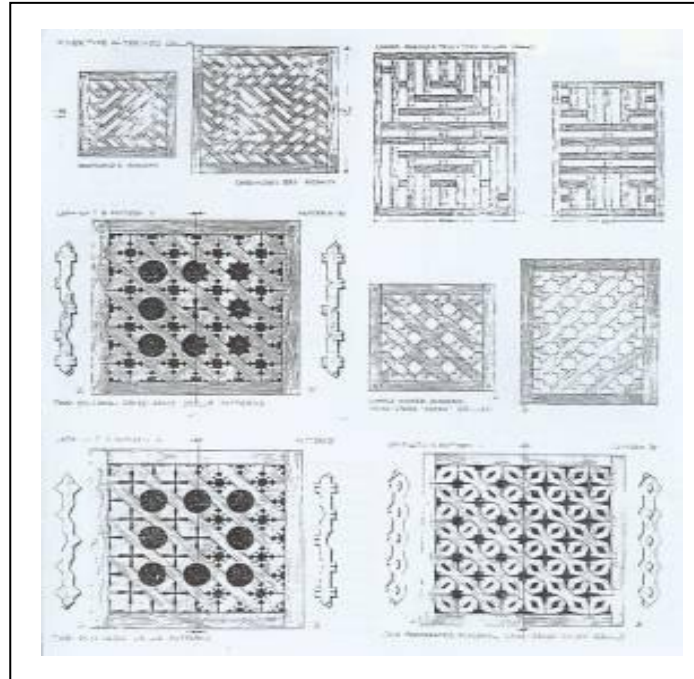

Figure 2-23 Sample 1 of wooden screen blow up, Wzira, Y.(1999)

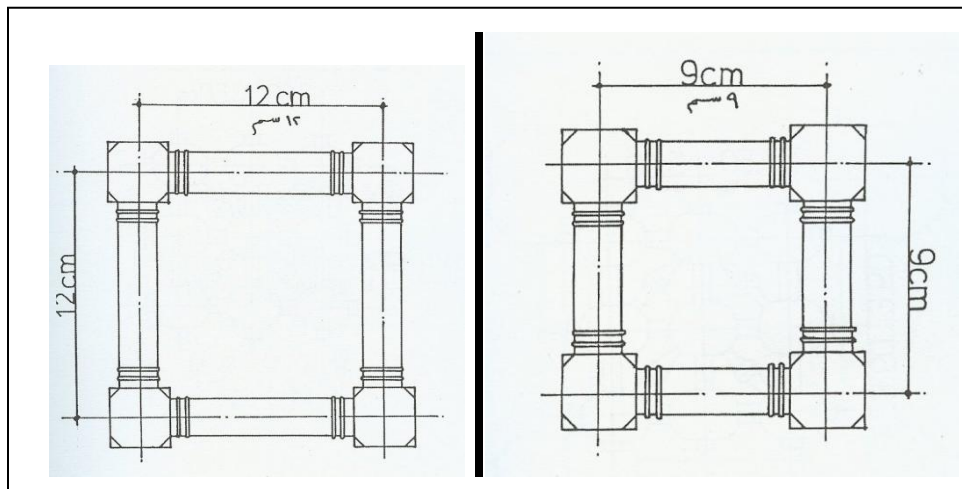
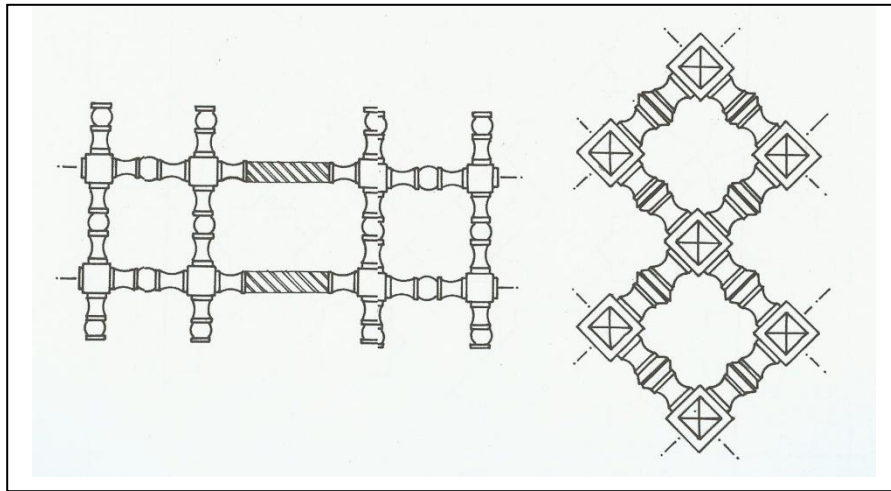

Figure 2-24 Sample 2 of wooden screen blow up 2, Wzira, Y.(1999)



The practical function of *Roshan*

Based on the aforementioned information, the main functions of *Roshan* could be summarized as follows:

1. Providing and controlling natural light that enters the building.
2. Providing and regulating the natural ventilation of the building.
3. Reducing the interior temperature of the building.
4. Providing privacy to the residents.

Those functions 1,3,and 4 of the *Roshan* are the main characteristics of the proposed shading device for modern houses in Jeddah that will be described in chapter four.

2.4.3 Development of the *Roshan*:

Throughout its history, the *Roshan* has continued to developed gradually until it reached the shape and design that has left its impression on traditional architecture and which can be found even today in the historical areas of the Jeddah and other cities. Researchers have studied and analyzed the design of the *Roshan* in order to benefit from those aspects of its design that allow it to function more effectively in Jeddah's social and physical environment.

Presently, due to the substantial changes that have occurred in the architecture as well as the society of the Hejaz, the traditional *Roshan* cannot be used as it was in the past. However, the positive attributes of *Roshan* can be identified and adapted to suite the contemporary culture and architecture of Jeddah.

Positive aspects of applying the *Roshan* concept in the modern world

According to (Hariri 1991), and based on two existing researches, the following four positive characteristics in the form of the *Roshan* have been identified:

1. Integration of form and function.
2. Reliability and durability.
3. Adaptability to the environment.
4. Suitability to the social and religious aspects of Islamic society.

Drawbacks of applying the *Roshan* concept to the modern world

In spite of the positive aspects found in *Roshan* as a concept, there are three major drawbacks to using the traditional form of the *Roshan* that, as a result, make it incompatible with contemporary *Hejazi* architecture and society

Loose fitting screens and openings are the first drawback to the traditional *Roshan*. Traditional *Roshan* contain a large number of openings and movable elements, such as slats and screens. Unfortunately, these provide access for insects and dust to enter the home. In addition, the presence of a large number of unsealed openings would allow precious, cool air from air-conditioning systems to escape and large amounts of hot air to enter. This obviously carries serious disadvantages in the areas of cleanliness, sanitation, energy efficiency and comfort.

As mentioned above, *Roshan* are made from such expensive woods as teak, ebony, oak, and mahogany. These woods are difficult to find locally and expensive to import. This raises the cost of construction and maintenance considerably.

Due to both its intricate design and considerable size, the construction of *Roshan* is highly labor intensive, requiring a great deal of time and special, experienced craftsmen to construct them, both of which are limited commodities in the modern world.

When attempting to develop a new shading element for contemporary architecture inspired by the *Roshan* concept, the researcher sought to apply the aforementioned advantages of the *Roshan* model while simultaneously trying to overcome the drawbacks. The positive aspects of the *Roshan* are mainly the reason behind selecting the *Roshan* as shading device to be inspired by. But the traditional setup of the *Roshan* was applicable to the environmental and social needs of its time, meanwhile the drawback of the traditional *Roshan* are identified comparing to the

environmental and social needs of the modern current situation in *Hejaz*, and here comes the purpose of this research, which is to develop the traditional *Roshan* to suite the environmental, social, and religious aspects of the modern *Hejazi* city of Jeddah.

2.5 Privacy: a main function of traditional *Hejazi* architecture

In Islamic society and according to Islamic law, an individual has the right to privacy in all aspects of his life. This is especially true in his home. Likewise, women in Islam are obligated to veil themselves in the presence of male who are not of close relation. In her own house, however, and in the presence of her husband, father, and brothers, this obligation is lifted. Therefore, privacy in the home is very important to the Muslim woman. Consequently, the design of entrances and windows needs to be properly studied. Traditional architecture of the *Hejaz* region is a great example of meeting the needs of the woman while providing natural light to the home's interior.

Traditional *Hejazi* architecture works in line with Islamic religious and social concerns, and it is the duty of the architect (*mu'alleem*) to design the home in such a way that it provides privacy for the inhabitants of the house. (Al Shareef 1996) has mentioned in his research the following five areas of focus in traditional *Hejazi* architectural design:

1. The entrance

It was noted previously in the description of traditional *Hejazi* architecture that homes in Jeddah normally had two entrances to each house in order to ensure the privacy of females; this sometimes included having two staircases as well. Another example mentioned by (Ebn Saleh 1997) is the way doors were not constructed directly opposite to one another. Instead, they were shifted in order to ensure greater visual privacy.

2. Multi-stories

It was also mentioned that areas of the home were categorized into public, semi-private, and private. In the traditional *Hejazi* houses, the ground floor was considered as semi-private and male visitors were allowed there. The upper floors were considered private, and these were where females and children carried out their daily affairs.

3. Screened openings

Both *Roshan* designs, those being the wooden lattice screens and louvered shutters, are types of window treatments used in traditional *Hejazi* architecture. They are socio-cultural responses to the external environment and were used in homes to enhance the privacy of their inhabitants. As such, *Roshan* served as a barrier between interior and the exterior spaces. Through the openings found in *Roshan*, inhabitants had the ability to see the outside world without being seen themselves.

4. Roofs and terraces

In the *Hejaz* region, higher rooms were more preferable as they received and circulated more air. Roofs and terraces were commonly used for sleeping and socializing, particularly in the hot summer season. To provide visual privacy for activities on the roof as well as to provide natural ventilation, a 1.8m perforated brick parapet was built around it. (Eben Saleh 1997)

5. Courtyards

Houses with courtyards were more common in *Hejazi* cities other than Jeddah. The courtyard, located in the home's interior, was provided so that inhabitants could have free and direct connection with the natural sky while maintaining a private lifestyle.

2.5.1 Contemporary solutions for visual privacy in houses

“One negative impact of globalization is that we are now making buildings that are not representing our social and cultural values and heritage” (Mahmud, p.2)

Recent architectural practices in Saudi Arabia ignore a main function found previously in the design of residential buildings: visual privacy. Accommodation for visual privacy is regarded as restricting and limiting design creativity. However, such accommodation is, in fact, a functional element of the design process that should not be neglected in professional consultation. In addition, it should not left for the client to solve after completion of the building (Eben Saleh 1997, p. 168).

Refer to figure 2-25/ 2-26 for some examples of recent solutions for visual privacy in residential buildings.

Figure 2-25 Example 1 of Contemporary Solution for Visual Privacy, (Source:

<http://www.sawater.com.sa/english/10b.html>)



Figure 2-26 Example 2 of Contemporary Solution for Visual Privacy, Author retrieved

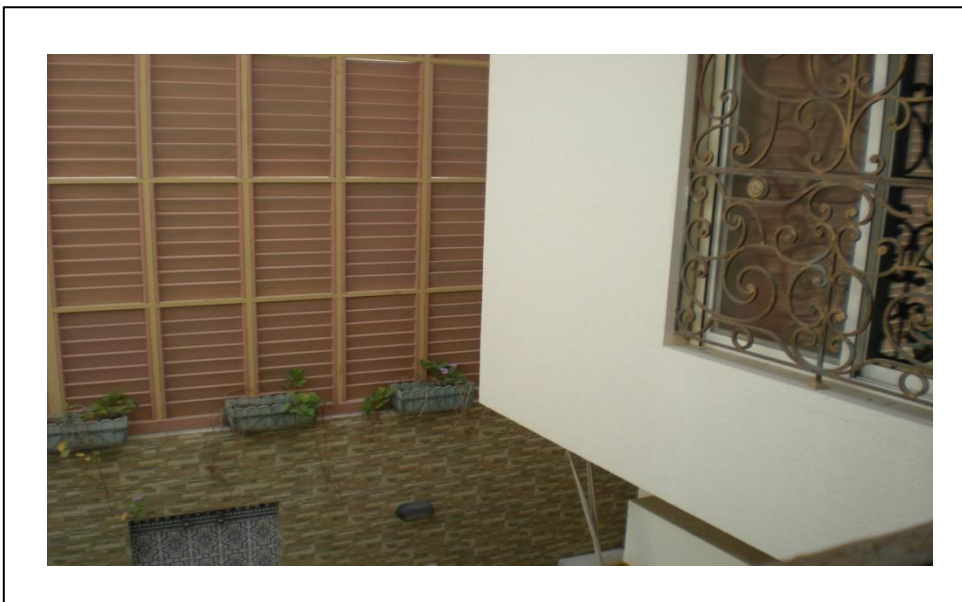

Solutions such as metal screens and high louvered fences are not in harmony with the design of the building; they destroy the aesthetics of the district and can be expensive. Other solutions, like opaque window curtains, discard the objective of installing windows in the first place.

With the recent economic boom in Saudi Arabia, many new high-rise buildings, residential compounds and commercial complexes are under construction. Designing such buildings without respect to the social, traditional and religious needs of the society will create a problem in the social development of said society and result in the acceptance of the urban change that comes along with it.

It is the duty of local *Hejazi* architects, designers and engineers to adapt new technological and global architectural trends in order to make them compatible with *Hejazi* social, cultures and religious needs. This is in order to create sustainable designs that uphold and improve modern life in the *Hejaz*.

2.6 Conclusion

In this chapter the researcher covered the history and background of the main subjects of the research, analyzed it to come up with main guidelines of the research.

The first part of the literature review was focusing on the natural lighting in architecture and its affect on the interior spaces, which can be concluded that natural lighting is a basic human need in terms of visibility, and the availability of comfortable natural lighting in houses has a positive effect on psychological and physical wellbeing of the household. Follows some investigation in basic natural lighting physics, its reflection in the interior spaces, and the material properties that can play a major role in the studied parameters. Based on the analysis and outcomes of the natural lighting physics and material properties the researcher were able to identify the parameters that should be investigated in this research, which can play a major role in the enhancement of the proposed shading device. As this research should propose a sustainable shading device therefore the comfortable natural lighting levels were indentified to be between 50-500 lux based on the conducted functions in the living room, and the energy efficiency of the natural lighting in this research is mainly concerned by cooling loads and demands of the tested room.

The second part of the literature review was focusing on the *Hejazi* town of Jeddah, and the *Roshan*. Jeddah was identified to be a coastal city that lays on the Red Sea, and characterized with a hot humid climate. Historical background of the city and its architecture was discussed in details to finally identify that the *Roshan* is originally influenced by many cultures most dominant are the Turkish and the Egyptian's, its meaning was identified to be "a source of light", and its function to be a sustainable shading device of its time that serves social, culture, and religious *Hejazi* needs. Later the researcher discussed the positive aspects and the drawback of the traditional *Roshan* to further develop the five proposed cases that will be explained later in chapter four.

In chapter three the researcher will investigate in the research methodology to determine the best method can test the research parameters.

Chapter Three: methodology

3.1 Introduction

This chapter will define the research parameters, in order to select the proper methodology that will investigate the research topic. There are many research methodologies can be conducted when investigating in an architectural topics, for example, the interpretive- historical research, the qualitative research, the correlation research, the experimental research, the simulation research, logical argumentation, and case study and combined strategies research. Groat and Wang (2002). Selecting the correct methodology to fulfill the research question depends on the research tested parameters and the aims and objectives of the research. When investigating in natural lighting levels and testing the best approach to provide comfortable natural lighting levels, there are not many. Most known approaches are experimental scale modeling and computer simulations. Each approach has positive and negative attributes. Based on the parameters that will be discussed and the targeted tests that will be conducted in the study the researcher found out that the computer simulation is the best methodology can be used in this investigation, and will be discussed further in this chapter.

3.2 Defining research parameters

The traditional *Roshan* design model, which was shown through historical documentation in the literature review, chapter two, section 2.2.3.2, to be a successful sustainable model for its time, will serve as the basis of this study. This study will propose a modern shading element design, referred to hereafter as *Roshan-p*, inspired by the traditional *Roshan*, which shall be referred to as *Roshan-t*. By applying multiple parameters of manipulation and reconfiguring the test environment with different natural-lighting levels, the main outcome of this study is to reach the targeted comfort levels of natural daylight while regulating the heat gain produced, thereby impacting the energy consumption of air-conditioning (cooling loads).

3.2.1 Reconfiguring traditional parameters

Roshan-t, as described in chapter two, will be used as the basis of this study. The reconfigured parameters of *Roshan-p* as a test model will aim to test two measures the natural lighting lux levels and the heat gain that will affect the required cooling loads and will be manipulated as follows:

Lux levels testing parameters

- **The openings**

These parameters will vary between 5x5 cm, 10x10 cm, 15x15 cm, and 20x20 cm based on the *Roshan-p* design approach, more details will be explained in chapter four section 4.2.2 under Modern house case study modeling.

- **The materials**

The properties of two materials will be tested. As mentioned in chapter two, section 2.2.3.2, *Roshan-t* was made of wood. Wood will also be used to test *Roshan-p* as wood is considered to be an absorber and a less reflective material. In addition, a highly reflective material, stainless steel, will be the other material used in order to study the impact of the material's reflective properties on daylight levels and heat gain.

Heat gain and cooling loads demands parameters:

- **The type of glass used in the windows**

In the *Roshan-t* model, there were no windows or glass used to protect the interior spaces in residential buildings as cooling the house depended on the passive cooling strategy of natural ventilation. Adding glass pane windows are essential in the modern urban environment in order to protect the interiors from noise pollution, dust, and insects as well as for the proper function of air conditioning systems. According to what has been discussed in the literature review section 2.4 of Hariri's experiment, adding the glass window from the inside of the house provides better heat insulation. However, some dust might accumulate between the *Roshan* and the glass panel. From the researcher's point of view, the positive qualities are more important for the sake of research.

- **Orientation**

Roshan-t will be tested three times a day during three days: June 21st, December 21st, and March 21st. These three days represent Jeddah's weather throughout the year: summer, winter and a transitional period between the two seasons. For the four main orientations (i.e. north, south, east and west), those with the highest outcomes in the areas of excessive natural-lighting levels, highest heat gain, and highest discomfort hours, will be further tested in accordance with the proposed designs in order to simulate the worst possible scenarios in an attempt at finding solutions for them. In case reasonable calculations are achieved for the worst orientation, other orientations will, by default, give better outcomes; thereafter, the optimum solution will be tested with the other three orientations in order to record results and make a final analysis.

3.3 Research Design and Methodology

When investigating in natural lighting there are not many methodologies can be used, that is due to the specific out puts that should be tested. The selection of the testing methodology basically depends on investigation measures. qualitative research, quantitative research, subjective research, case study, experimental research, computer simulation research , and combined strategies are all methodologies can be adapted for natural lighting investigation.

Through literature review of natural lighting investigation methodology some examples can be discussed. An example for a subjective research is a study was conducted on an overall daylight performance, which was a conjoint analysis approach on subjective preference to day-lit residential indoor environment done by Cheung and Chung (2007) seven parameters were selected; general brightness, desktop brightness, perceived glare, sunlight penetration, quality of view, user friendliness of shading control, and impact on energy. However since it is a subjective approach the study was conducted through a survey to evaluate which attribute is most important measure to the users of the investigated space. But when testing natural lighting levels illuminance the subjective research approach is not appropriate to give the desirable results. Another example of quantitative research which investigate in view, direct light transmission and interior illuminance has applied mathematical equations, the research was done by Tzempelikos (2008) testing three types of venation blinds as a shading device, 41 equations were used a long procedure was processed to come up with convenient results. Mathematical equations methodology is mainly an engineering approach, Using this approach when testing natural

lighting measures is a lengthy and not an easy task for architects nor designer, and the difficulty of this it usually discourages un-engineering background from investigating in the subject.

Finally an example of a combined research methodology by Greenup and Edmonds(2003) where they used experimental scale model and computer simulation using Radiance to test a micro-light guiding shade, which is a shading device that acts as a shade for the façade and distributes the sunlight deep into the building in sub-tropical climate. The research was experimenting effectiveness, efficiency, implementation, cost and construction of the device, the computer simulation has been used to find the optimal configuration of the panels in various situations, and times. While the experimental model tested the depth of illuminance penetration, and glare redirection from occupants. The researcher explained in his paper that the use of the computer simulation was intended to accelerate the optimization of the study, and to reduce the time consuming experimental work and cost. A good validation of Radiance was conducted by Greenup and Edmonds, and a compatible results of experimental model and Radiance simulations were achieved.

Combined research methodologies can be one of the best approaches when testing natural lighting levels of a shading device, where each methodology can complement the other in case of shortage in testing a certain parameter or measure.

According to Baker (2001), there are two types of research methods when investigating natural-lighting levels calculations: experimental scale modeling and computer simulation.

3.3.1 Experimental scale modeling

Experimental scale models can be divided into two types. The first type involves testing under simulated conditions in a laboratory, such as in the sky dome. The second type involves testing in a real-life setting, often referred to as *the field*.

Al-Jofi (1995) has conducted three experimental investigations in his Phd thesis, the first two investigations were 1:1 scale model in the lab to test illuminance levels for a single opening 3x3 cm of traditional *Roshan*, unfortunately the investigations resulted of an invalid data due to the small size of the opening which resulted in a less than 2 lux levels that cannot be measured by the used device. Therefore he conducted a third investigation of multiple *Roshan* screen openings, Although the third experiment was reasonably successful, nevertheless he decided that the

conducted experimental method was inconsistency and invalid. And he adopted mathematical equations to proceed with the investigation. At the time of Al jofi experiment computer simulations were not popular among researcher, otherwise testing delicate design parameters needs to be accurately designed and can be easily tested with such an approach.

Figure 3-1 The Megatron architectural model lux-meter **Figure 3-2** Model of second experiment Al-Jofi (1995)

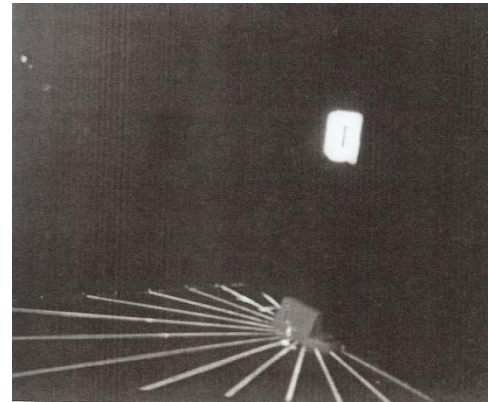
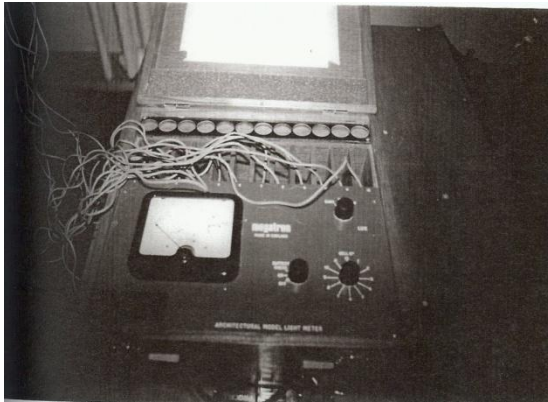

Many architectural investigations were conducted in real life settings, and proof to be scientifically reliable, especially when there is a lack in another investigation methodology for the subject, A good example can be applied in a field experiment that was conducted by Ip et al (2009) investigating in shading performance of Virginia Creeper as vertical deciduous climbing plant canopy. He attempted to proof that this kind of vegetation incorporate within the facade can act as dynamic solar shading façade because it is responsive to the seasonal climatic change, as the density of the plant respond positively with the daylight availability and the seasons. The experiment took place in southeast UK for the period of two years, the researcher had to develop a thermal model to identify the key parameter for establishing the Bioshading Coefficients function, because there was a lack of existing methodology and measurement techniques.

Figure 3-3 Field experiment investigation, Ip et al (2009)



Other examples of field experiment in natural lighting, M. Hariri (1986) conducted an investigation on experimental scale modeling. He attempted two field studies on a 1:1 scale model. The first experiment was to copy the same *Roshan-t* design in terms of size and material. He added a *Roshan-t* from the inside of a double-glazed window and utilized a metal screen for protection from insects.

The second field study was also a replication of the *Roshan-t* with some modification to the materials and details. He added a double-glazed window to the outside of the *Roshan* and replaced the mahogany wooden louvers with aluminum louvers on the interior side of the *Roshan*. In his book Hariri stressed on the benefits of conducting this field study, the outcomes were used in many research and developments specially in commercial building in the holy cities in Makah and Madina, due to the use of traditional architecture as a theme for these buildings. Outcomes of Hariri field study were analyzed as positive and drawback aspects of applying the *Roshan* in modern world, in the literature review in chapter two, section 2.2.4.1.

Unfortunately, this was the only documented field experiment in the development of a modernized *Roshan*. Although Hariri has mentioned field experiment attempts by the Makah Company for Construction and Development, no validated references were found.

In the case of experimenting with natural-lighting, using scale models provides excellent validated outcomes that simulate reality through the construction of accurate models that duplicate the exact geometry, material surface reflectance, reflectivity and color of the natural environment. A major reason for this method's adaptability is that the wavelengths of visible light are very short compared to the size of the model.

On the other hand, there are some limitations when experimental scale modeling is adopted as a research tool; those limitations are as follows:

- A detailed, physical scale model can be very expensive.
- Materials used in the real world can prove very difficult to shape and form in order to be used in a scaled-down physical model.
- Special-equipped laboratories are rarely available.
- Average sky conditions cannot be determined in the case of field settings.
- Sensors must be connected to a data logger with recording ability in scaled models under field settings due to the limited availability of the daylight.

3.3.2 Computer simulations

Recently computer simulations became popular among architect and designers especially when they are used in the research conceptual phase, computer simulations replaces sophisticated mathematical equations where it encourages architects and designers to take the initiatives in investigating environmental solution prior final architectural solutions. Compatibility of different architectural, environmental, and rendering software made this approach even easier and more user friendly. Shaheen (2006). a good example are Auto desk software, of Auto Cad and Revit are popular internationally among designers and they are compatible with Ecotect and Radiance where many environmental measures can be tested and simulated.

As mentioned previously, the second type of research method used for investigating natural-lighting levels is computer simulation. In order to calculate daylight levels by this method, there are two approaches that can be used: radiative transfer and ray tracing (IES) (Rea 2000, p. 8-10). The first approach, radiative transfer, uses a finite-sum approximation to determine the sky and sun components. It uses only small parts of the sky that directly illuminate the measured point. Usually, such an approach considers all the reflectant surfaces of the room as diffused.

Calculations can become very complicated if the geometry of the model is complex. On the other hand, the second approach, ray tracing, is relatively slower in simple geometry calculations, but it is capable of calculating complicated and detailed geometries. Radiance software utilizes ray tracing and has been selected for this research based on the need to target outputs of the detailed shading device in light of the varied reflectance of selected materials and for realistic visualization.

3.3.3 Selecting the research methodology

After investigating in a couple of natural lighting research methodologies, and based on the literature review that has been done on the subject, two steps of investigation will be followed, first the research to be investigated through literature review secondly the hypothesis will be tested through computer simulations. Computer simulations can test the various parameters that have been mentioned in section 3.2.1 and the reasons will be listed as the following

- Flexibility, in that computer simulation can model any proposed design.
- Compatibility with other software; for example, inputs can be created in the Auto CAD system and translated into DXF, a form that simulations can accept.
- Cost effectiveness, as a complex design is cheaper compared to constructing a physical scale model.
- The Ability to test different parameters in considerably short time.
- Convenience, especially when designs are evaluated parametrically.
- Comprehensiveness, as simulations can calculate many factors, including illuminance and daylight factors.
- Transmittance calculation capabilities for diffused and specular properties
- Ability to calculate in conditions of CIE overcast and clear sky.
- Production of realistic rendered images.

The above mentioned points indicate that using computer simulation as a research method seems to be a method by which the researcher can test different design hypotheses using varied parameters. Later in this chapter, under validity and reliability, the researcher will validate the use of Ecotect and Radiance software and will defend the selection of these particular software programs. The next section will give an overview of Ecotect and Radiance and their usage in the research.

3.4 Ecotect software overview

Autodesk Ecotect Analysis is environmental-analysis software that allows designers to simulate building performance from the conceptual stage of the design. It was developed to test different aspects of building performance such as whole-building energy, thermal performance, water usage and cost, solar radiation, day lighting, shadows and reflections.

Initially, Ecotect software was developed by Dr. Andrew March from Square One Research Lab. Later, it was acquired by Autodesk and incorporated as part of software packages.

3.4.1 The Use of Ecotect in this research

In this research, Ecotect was used to build a three-dimensional, surface geometry model of the traditional *Hejazi* house while applying the specifications of the *Roshan*. This was done in order to evaluate its performance in terms of natural lighting regulation by looking at how many lux levels were accepted at that time by building occupants.

Along with this, Radiance, which is an underlying simulation engine, was used to render the modeled building into a three-dimensional, virtual-reality image and to measure the three-dimensionally simulated lighting levels.

3.5 Radiance software overview

Radiance was originally written at Lawrence Berkeley National Laboratory by Greg Ward in 1985. It "...uses ray tracing to perform all lighting calculations, accelerated by the use of octree data structure. It pioneered the concept of high dynamic range imaging" (Radiance website).

For the past fifteen years, its capability and development have been constantly expanding. It is a complete visualization system which calculates numerical results and produces photo-realistic renderings.

The lighting analysis of the program is based on reverse ray-tracing methodology. It initially generates rays of light at a measured point. Then it traces them back to their sources. (Greenup and Moore, 2001; Baker and Steemers, 2002)

3.6 Validity and reliability

Evaluating natural lighting quality and quantity in any space is difficult to do using mathematical equations. The design and research industry is relying more on computer simulation methods to calculate different measures of natural lighting.

In order to validate the use of Radiance as an experimental methodology, a literature review of previous scholars work has been investigated, and discussed as following

Based on a research paper that was published by R. Christoooh, and F. Annegret in 2006, a well-studied literature review of the evaluation of day lighting software programs was conducted to investigate the validity of these packages.

Due to the rapid development of technology, the number of researchers using scaled model measurements has gradually fallen while the use of computer simulations has risen, as reported from the findings of a survey that was conducted in 1994

The objective of an online survey that was conducted in 2004 by the above mentioned authors was to re-evaluate existing daylight design software packages. The survey was completed by 185 individuals from 27 countries: 20% working in Canada, 20% working in the United States, and 12% working in Germany. Their professions were varied with 38% working as energy consultants and engineers, 31% as architects and lighting designers and 23% as researchers.

The largest number of applicants (91%) used day lighting evaluations in their proposed designs while 79% used computer generated simulations to test them. The majority reported that the objective of using these computer simulations was to design developmental and parametric studies of day light rather than schematic, preliminary proposals.

One of the major outcomes of the survey was the finding that from a selection of 42 different daylight simulation programs, over 50% of the applicants used Radiance as a simulation engine in order to calculate daylight factors and interior illuminance. The main day lighting aspects tested were shading devices and natural-lighting controllers.

Another study was conducted by Li and Tsang in 2005 comparing between an onsite measured illuminance daylight levels and a simulated by Radiance of a naturally lit corridor. the results reveals a good agreement between the physically measured by sensors and the simulated results, and it was stressed in the research theses results clearly verify the accuracy of Radiance.

Measured and simulated results comparison are found in figure 3-4

Figure 3-4 Measured and simulated indoor illuminance for sun-facing surface under non-overcast skies, Li, D. and Tsang, E. (2005)

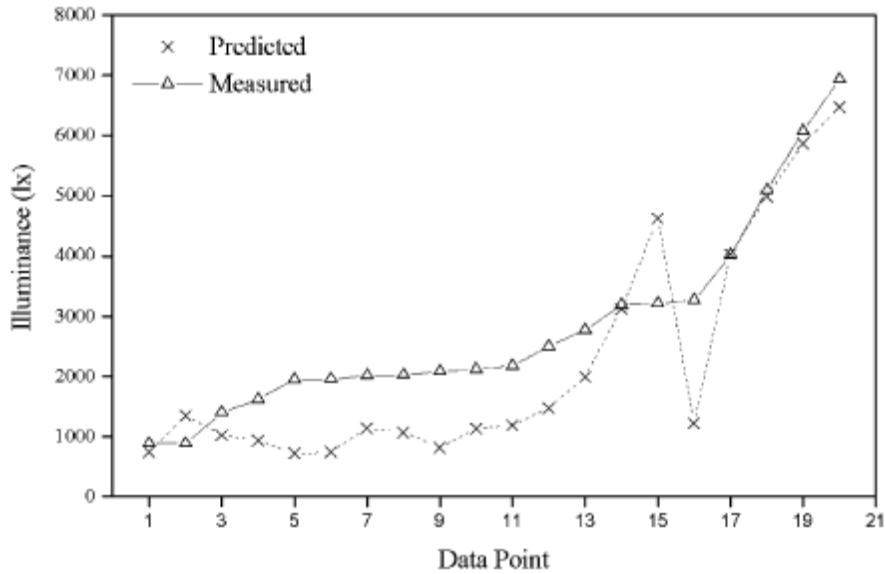

According to Hviid et al (2008) in a research paper introducing a simple tool to evaluate the impact of daylight on building energy consumption “Of the numerous lighting simulation programs available, Radiance has been extensively validated and repeatedly surpassed competing programs in terms of both functionality and accuracy”. Hviid et al (2008) validated the proposed tool that integrates daylight and thermal analysis by comparing it with Radiance results claiming that Radiance is considered most validated natural lighting simulation tool available. Results of both software were very compatible refer to figure 3-5.

Figure 3-5 Comparison of case where opposing building obscures part of the sun and sky. Clear double low-E glazing. Hviid et al (2008)

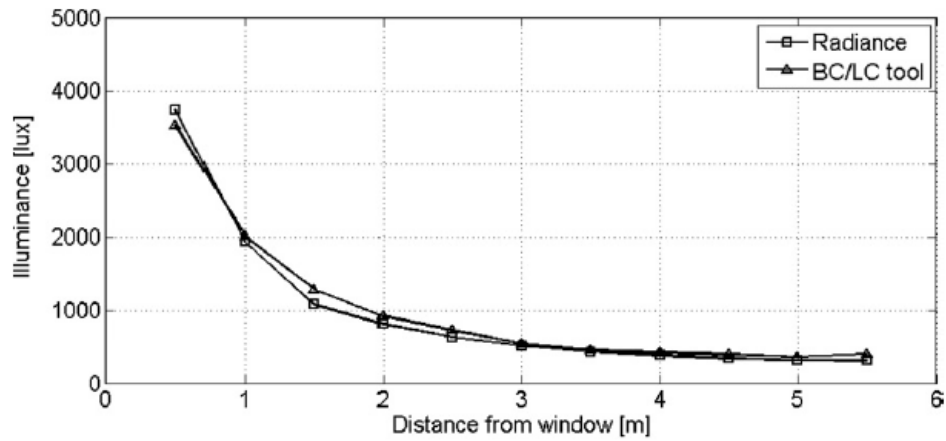

Finally, Baker and Steemers (2000, p. 197) stated, “Radiance is a very accurate program with many powerful application possibilities.”

In this chapter the researcher defined the research parameters, and investigated through literature review the proper methodology will be used, then an overview of the selected software was displayed validating the proper selection. In chapter four, the design hypothesis will be built in the software, thereby allowing different parameters to be tested. A detailed explanation of the setup process will be provided while all input information will be mentioned and output results analyzed.

Chapter Four: experimental investigation

4.1 Introduction

In this chapter, the researcher will explain the research plan, which consists of four steps; step one is about building the *Roshan-t* as a reference for the study, discussing the inputs and outputs on Ecotect and Radiance, step two is proposing five case studies for *Roshan-p*, discussing the manipulated parameters, and building the cases in the software, step three is taking the most successful proposed case for further tests and reassurance of the positive outcomes, step four which will be discussed in chapter five and it concerns the cooling loads calculating for *Roshan-t* and *Roshan-p*, as a final results and analysis.

4.2 The Research Plan

The research plan is divided into four steps to make it easier on the researcher and the reader to follow the conducted investigations. First the *Roshan-t* will be built and the worst directions for an excessive lux level will be identified. Secondly, five modern *Roshan* design cases will be presented using worst orientation identified in the first step. Third, the best proposed scenario will be tested over the other three directions. Finally, the lux levels and cooling loads of the selected case will be compared with the traditional setup.

Step One:

The *Roshan-t* design setup will be built as a three-dimensional model in Ecotect and then exported to Radiance. The lux levels will be measured three times a day, three seasons a year and over four directions as will be explained in the next section. The worst direction in terms of excessive lux levels will be identified.

Step Two:

The researcher is proposing five design cases, each of which will present modern shading solutions that are inspired by the *Roshan-t*. Each will be built in Ecotect, and lux levels tests will be conducted three times a day, three seasons a year, and over the worst identified direction from the traditional setup tests in step one.

Step Three:

The most successful case in terms of achieving desirable lux levels will be tested over the other three directions, during the three selected seasons, three times a day in order to demonstrate that the selected case is the most suitable solution for the presented problem.

Step Four:

As a final step, the lux levels and cooling loads of the selected successful case will be compared with the traditional setup results and analyzed to present the suitability of the selected case for modern houses in Jeddah.

4.2.1 Step One: Traditional house case study modeling

Inputs and model setup on Ecotect

In order to conduct Ecotect simulations, a three-dimensional surface geometry building should first be created, materials should be specified, and light sources should be provided. Then location, weather, date, and time should be specified as well.

Figure 4-1 Perspective view of traditional building generated from Ecotect

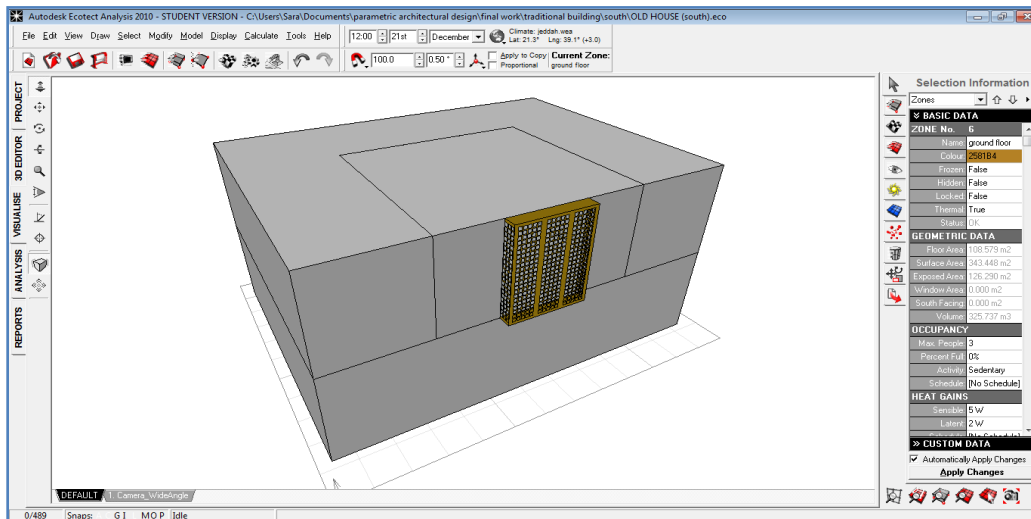

Complete building information was collected in the literature review in section 2.2.3.1, and a case study sample of a typical, medium-sized villa was selected and modeled in Ecotect. The most commonly used room in the traditional residential building is the first floor living room, which has the largest *Roshan* in the house. This room was selected to be the test sample, and the reasons were explained earlier in the chapter two.

The dimensions of the tested room are 6 m in length, 6 m in width, and 3 m in height, as these dimensions represent a medium size room for modern houses and a large size room in the traditional houses as has been displayed in the case study typical *Hejazi* house in figure 2-14 section 2.2.3.1

In order to control the calculation time, the building's architecture was simplified. A corridor measuring 3 m in width and 3 m in height was created for the three sides surrounding the tested room, thereby creating an interior boundary between the external environment and the tested room.

The dimensions of the *Roshan-t* are 2.4 m in width, 3 m in height and 40 cm in depth (projected from the building). The openings of the *Roshan* are divided into three vertical panels. Each panel has 5 by 22 openings and each opening is 10 cm high and 10 cm wide. The sides of the *Roshan* contain one panel that has 3 by 22 openings, and each opening is 10 cm high and 10 cm wide. These dimensions represents accurately what has been research in the literature review.

Figure 4-2 Traditional *Roshan* Details as built on Ecotect

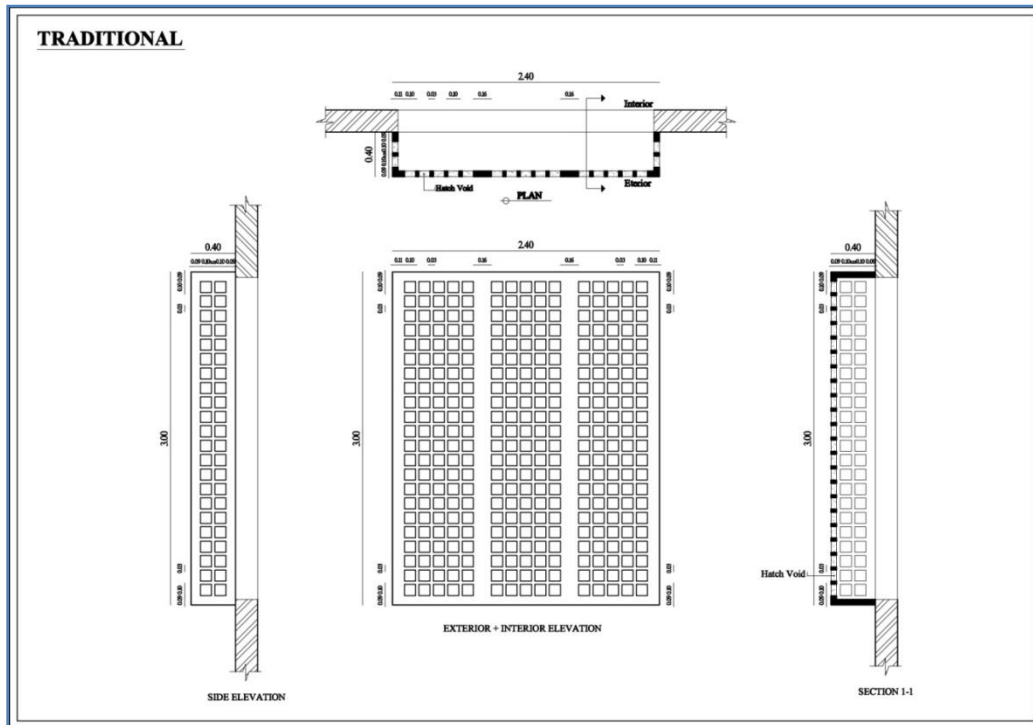
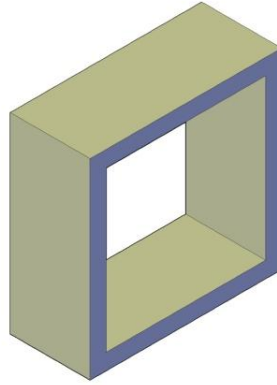

Figure 4-3 *Roshan-t* opening blow up



The building materials were selected in Ecotect as follows:

- Architectural walls: brick concrete block with plaster
- Ceiling: suspended plaster insulation
- Interior walls: framed plasterboard partition
- *Roshan* material: panel as solid wood
- Openings of the *Roshan*: void.

More specifications are provides in Table 4-2

Table 4-2 Buildings Material Specifications as built on Ecotect

Material	Material Description	U-Value (W/m²k)	Solar Absorption	Thickness	Reflectance
Roof	10mm suspended plaster board ceiling, plus 50mm insulation, reflective foil (for heat retention), 150mm joists as air gap, building membrane, and ceramic tiles.	0.61	0.5	0	0.502
ceiling	10mm suspended plaster board ceiling, on 200mm joists as air gap. No insulation.	4.32	0.365	210	0.8
Floor	100mm thick concrete slab on ground plus ceramic tiles.	0.88	0.475		0.8
Wall	110mm brick plus, 220mm concrete block with 10mm plaster inside.	1.88	0.7	340	0.8
Partition	80mm framed wall as air gap, with 10mm plaster board either side.	2.2	0.4	100	0.8
plane 1	10mm solid oak.	4.39	0.636	10	0.4
plane 2	1.5mm stainless steel.	5.55	0.284	1.5	0.8

Figure 4-4 Traditional *Roshan* daylight reflection generated on Ecotect

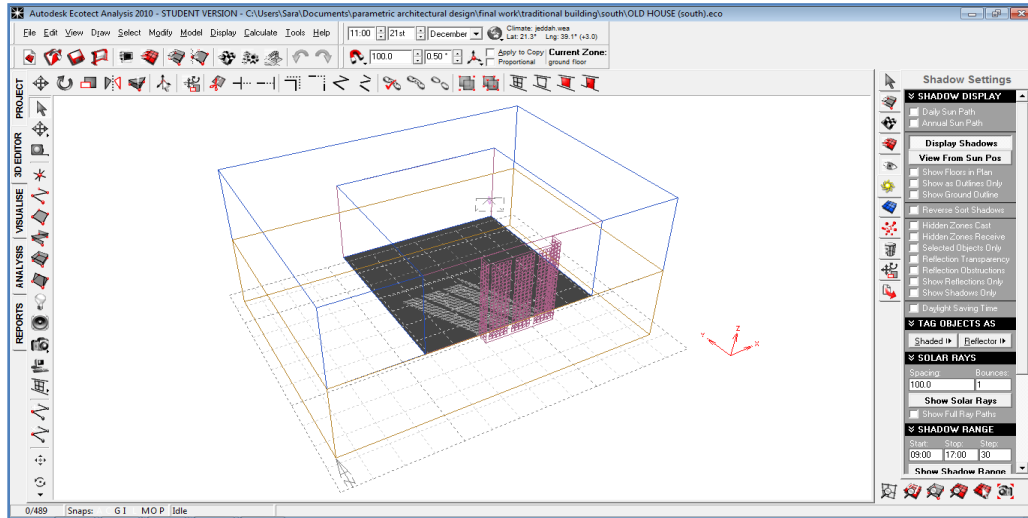

The analysis grid is a two or three dimensional mesh plane which calculates different variables like lighting, insulation, spatial comfort, and computational fluid dynamic (CFD) cell blockages. It should be positioned on the required plane to calculate the required measure. This research is focused on natural lighting; therefore the analysis grid is positioned on the floor plane and elevated 36 cm from the floor level to calculate most surfaces measured by human factors that reflect natural lighting from the Roshan. The precision control of medium was chosen for the calculation in order to better control calculation time as the *Roshan* contains many geometric details. The precision setting essentially determines the number and density of sprayed rays from each point of the grid node. The more precise the calculation is, the more time it requires. Window cleanness was chosen to be average to reflect normal window conditions in Jeddah. The design sky illuminance was chosen to be 8500 lux, as recommended by Ecotect. The CIE Standard Overcast Sky for the total unobstructed illumination of a heavily overcast sky is 5000 Lux on the horizontal plane. This is the value for a uniform overcast sky during daylight hours, sunrise to sunset, for all seasons within the year.

Figure 4-5 Roshan-t grid analysis lux levels generated on Ecotect

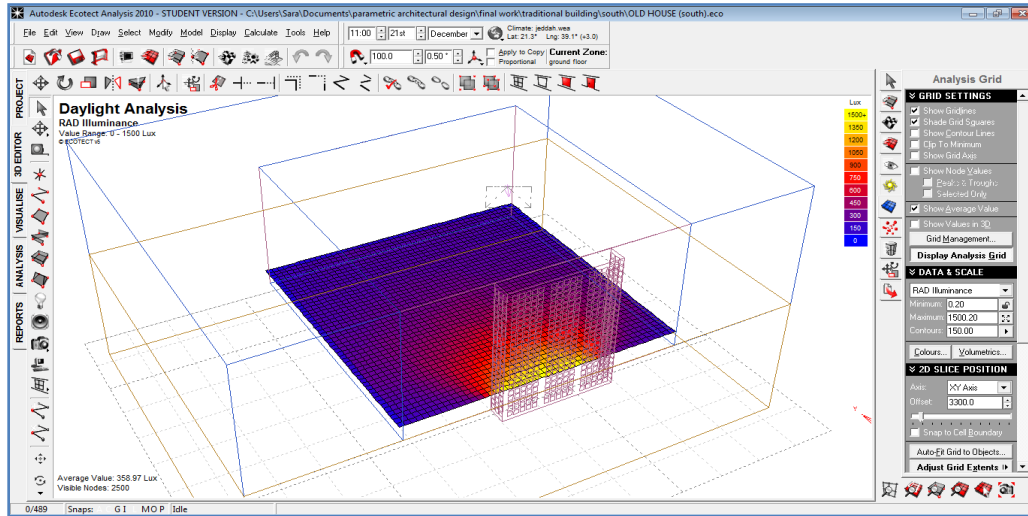
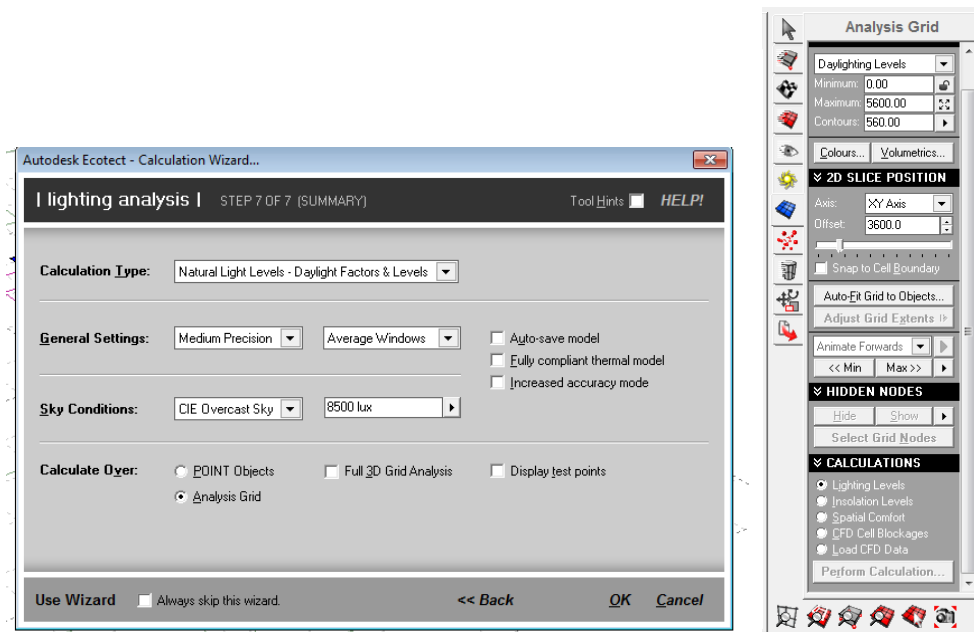

Figure 4-6 Calculation Wizard 1 of Ecotect



Date and time calculations for three days per year were selected to perform the calculations. According to the weather data on the weather tool application by Ecotect, the 21st of December represents the winter season, the 21st of June represents the summer season and the 21st of March represents the spring season; the 21st of March will also be used to represent the autumn. The weather of Jeddah is categorized as having mild differentiation between seasons, only two

seasons can be recognized throughout the year, and the time between the two seasons is represented by the 21st of March. The time of the calculations was selected to be 9 a.m., 12 p.m. and 3 p.m., representing the position of the sun during the different times of day: the early morning, midday afternoon and the late afternoon.

Figure 4-7 Perspective view of the Sun position of the traditional building on December at 12 p.m.

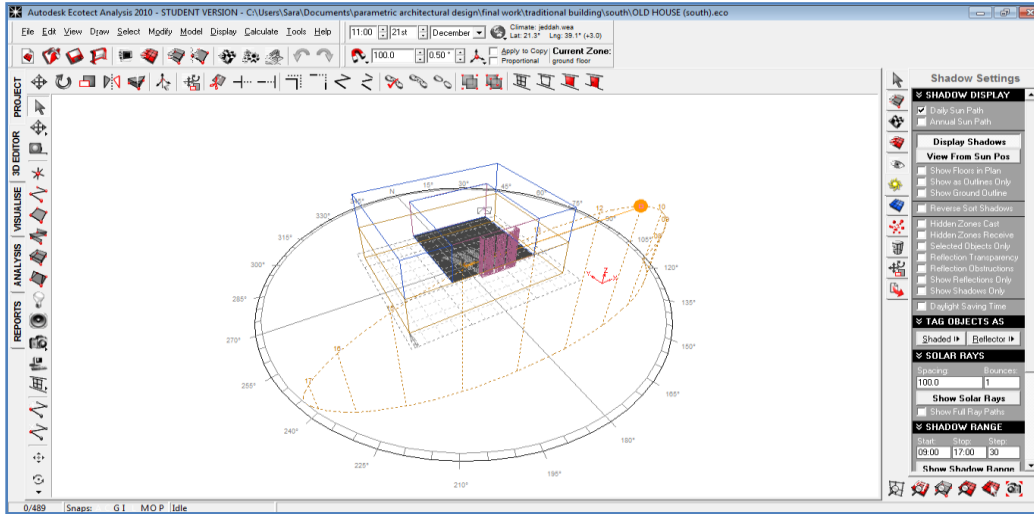
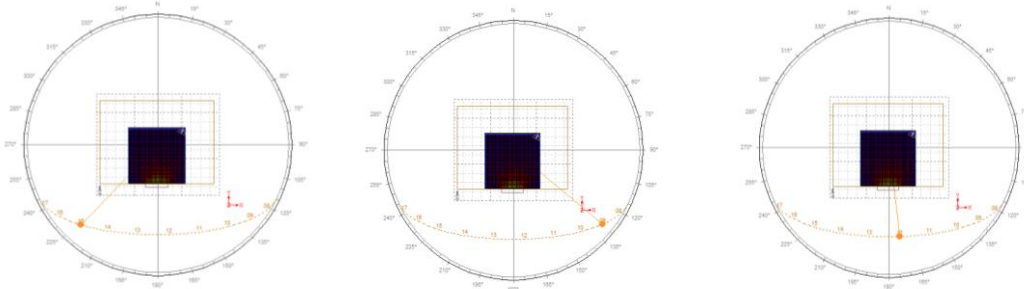

Figure 4-8 Plan view of the Sun position of traditional building on December at 9a.m., 12p.m. and 3p.m.



The building orientation for each direction (i.e. north, south, east, and west) was tested nine times for each direction. As shown in the table 4-6, the total number of calculations for a traditional house case study setup is 36 tests.

Outputs

The time required for the natural lighting levels calculation of this building is between 30 to 45 minutes. When the calculation is completed, the blue colored grid analysis displays the results as colored points. Each point is colored in the appropriate degree that represents the lux level and is translated using the displayed colored key legend placed on the right side of software interface. Multiple information can be identified by the same grid analysis calculation.

Radiance

The Ecotect model file data was exported to Radiance after selecting the calculation and viewing the setup as shown below.

Figure 4-9 Calculation wizard 2 of Ecotect

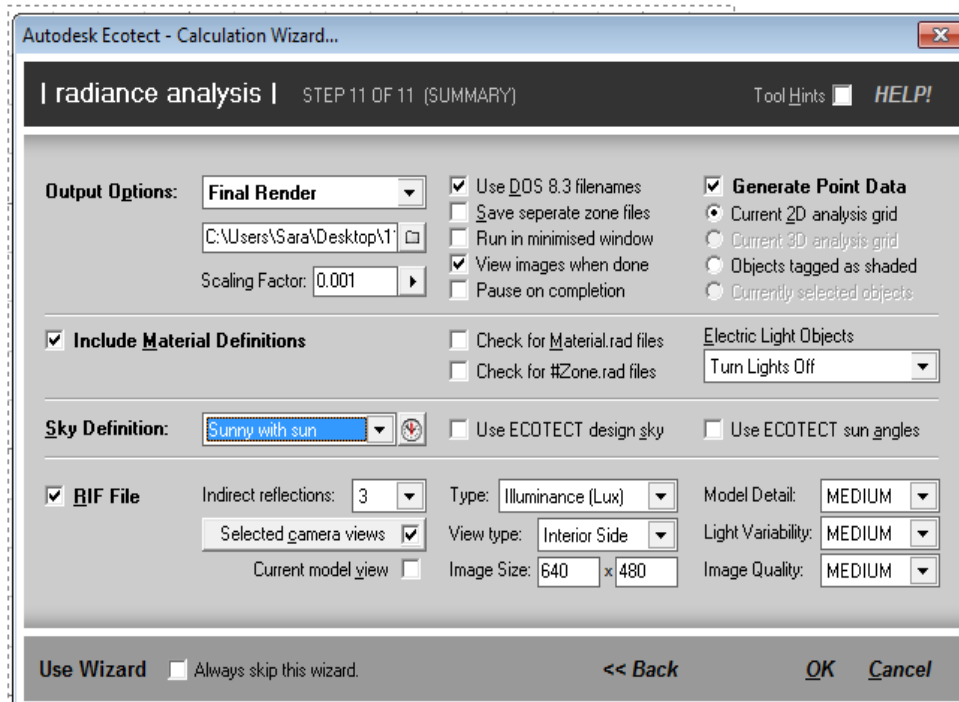

The output view options were selected for the final rendered image and the data was generated from the three-dimensional analysis grid previously calculated by Ecotect. The material definitions were chosen to be included as they had already been specified in the Ecotect file for each element. No artificial lighting was available. Due to the hot, humid climate of Jeddah, Saudi Arabia, the sky definition was chosen as sunny. Under the RIF file, three reflections on which to base the calculations were chosen. The number three is normally considered to be too few;

however, it reflects the reality of material space. The type of calculation used to calculate illuminance lux levels of the interior, model detail, image quality and light variability were all chosen at medium levels in order to control the calculation time.

Radiance automatically opens a calculation window to generate all the needed information and displays any errors found.

Figure 4-10 Exporting Ecotect File to Radiance

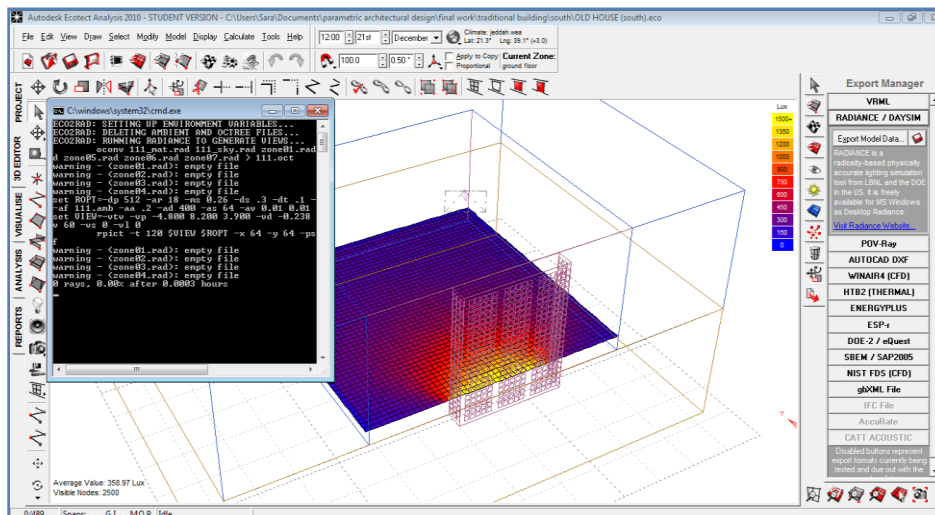

Finally, the interface of radiance opens automatically and displays image from a three-dimensional perspective. Here, the lux level can be measured on any point of the image. Contour lines, contour bands, and daylight factors can be also selected and calculated for the same output image using Radiance.

Figure 4-11 Radiance generated image

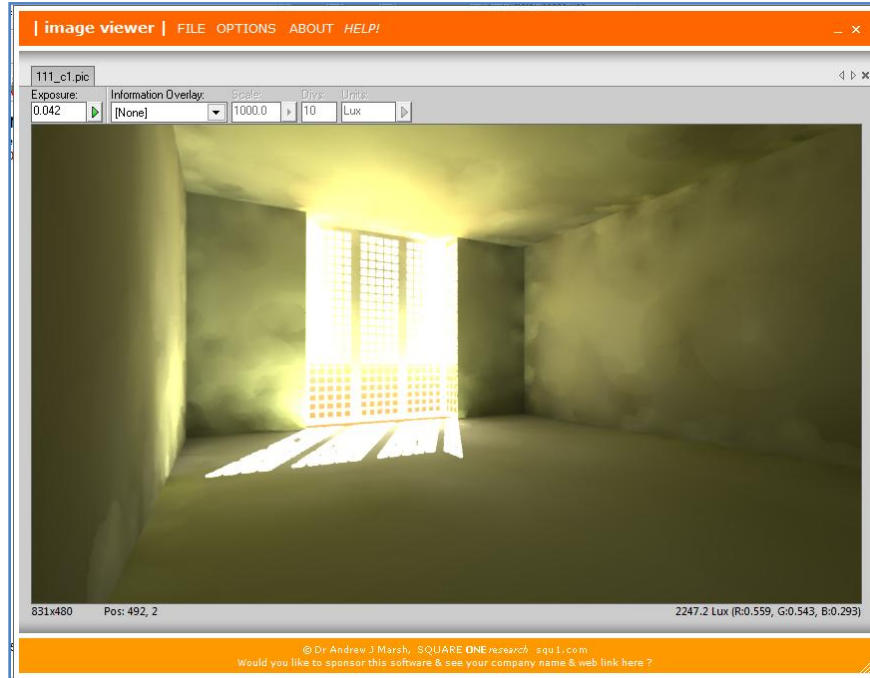

Figure 4-12 Radiance generated image with Lux Levels



Traditional setup tests results are shown in the table 4-3

Table 4-3 *Roshan-t* Lux levels

Traditional Setup										
	Lux Levels (Illuminance)									Lux sum up
	December			March			June			
	9 a.m.	12 p.m.	3 p.m.	9 a.m.	12 p.m.	3 p.m.	9 a.m.	12 p.m.	3 p.m.	
North Traditional	200	284	236	286	342	318	318	629	498	3,111
East Traditional	3,606	451	237	4,651	544	292	4,034	686	303	14,804
West Traditional	198	368	2,784	248	389	3,616	275	587	2,756	11,221
South Traditional	3,464	5,409	2,859	600	1,512	327	324	566	358	15,419
Highest Reading	E	S	S	E	S	W	E	E	W	

From table 4-4 and based on *Roshan-t* tests, the southern and eastern directions seem to have the worst readings of excessive lux levels when comparing a one-hour sample of all four directions, in this case 9 a.m., 12 p.m. or 3 p.m.. The highest reading was four out of nine readings for the eastern side. The southern direction received three out of nine, making it the direction with the highest reading for lux levels. The remaining two readings were from the western side at 3 pm. This is expected because the sun's position at sunset is very low from the west.

When comparing the sum of all readings for each direction separately, the southern direction had the highest lux levels while those for the eastern direction followed closely behind. Therefore, the researcher decided to conduct further tests to evaluate these results in greater detail. The results shown for indirect solar gain of the southern direction received the worst reading of all. Though the difference between readings for the south and the east were not great, they nevertheless proved that the southern direction should be considered as the worst orientation for a window to be placed in houses located in Jeddah.

Table 4-4 Indirect solar gain for *Roshan-t* on four orientations

Direction	Indirect solar gain
N	78,628
S	86,305
E	78,637
W	68,972

When the tests were conducted to investigate the indirect solar gain for the *Roshan-t* oriented on four directions north, south, east, and west, results shows that the south direction receives the highest indirect solar gain, and that was a second evidence to consider that south oriented windows in Jeddah houses are the worst of the other four orientations.

4.2.2 Step Two: Modern house case study modeling

As mentioned earlier in the research plan, section 4.2, the five cases proposed by the researcher were built and tested on Ecotect and Radiance according to the modeling details mentioned previously in the traditional *Roshan* setup (Step One).

The tested parameters of the five proposed cases were as follows:

As mentioned earlier that the *Roshan-t* was projected 60 cm from the exterior of the building, mainly that projection was used for cooling the interior by natural ventilation, where people can lay down in it when the weather is hot, or to cool the drinking water. It has been decided earlier that a glass window should be used to protect the interior space from insects and dust, and to well maintain the air conditioning systems that are essential for modern houses. Therefore the researcher decided to keep the proposed *Roshan-p* cases with no projection for two main reason: first absents of the main function of the projection which is providing natural ventilation, secondly *Roshan-p* should be applicable to modern architecture simple lines and styles, where the projection will give the traditional look of ancient buildings, and that will not be accepted by architects nor clients who are seeking modern contemporary designs.

Parameter that affect light penetration:

The opening size and shape are the primer parameters that affect the quantity and quality of light penetration into the interior space, and was selected as the following:

1. **The Opening Size**

The opening size was varied in order to test the effect of the size on the quantity generated lux level inside a room. In (Al Jofi 1997) study, he tested 3x3 cm openings. However, from the literature review, it was seen that there are many sizes of *Roshan* openings. And as Al Jofi mentioned 3x3 cm openings seem to be too small for a reasonable amount of natural light penetration. Therefore, opening sizes of 5 cm x 5 cm, 10 cm x 10 cm, 15 cm x 15 cm and 20 cm x 20 cm were tested based on the case design.

2. **Opening Shape**

The aim of testing different shapes of *Roshan* openings was, to test the light penetration in terms of quantity in lux when the quality is manipulated. meaning when the shapes of the openings were manipulated in each proposed case, there are three types of light were tested, 1- direct natural lighting, 2- indirect natural lighting (Reflected) 3- diffused natural lighting. these three types are different quality of light. Refer to section 2.2.2 daylight component in chapter two. in each case the researcher aims to determine the effect of the quality of light on the quantity of light when testing the lux levels. Different quality of light were tested according to the case details listed later under each case.

Parameter that affect energy efficiency

3. **Opening Material**

Two types of opening materials were selected, timber and stainless steel. Timber is the original material used in *Roshan-t* and represents a more absorbent, less reflective and dark colored material while stainless steel represents a more reflective, smoother, and more lightly-colored material. Of course the more absorbent the material is the

more heat generated and less light reflective it will be, and the more bright and reflective the material is the less heat and more light it will reflect. The selected materials will be tested on each proposed case, and will be described in details under each case.

4. Window Glass Type

Two types of window glazing were selected. The first was a single glazed normal glass with an aluminum frame, which is the basic window type with no treatments for heat reduction or efficiency. The other was a double glazed low E aluminum frame, which is the recommended glass type used in Jeddah houses for the availability of the double glazing and low E coating as a treatment to reduce heat transmission. The specifications that will affect the heat transmission and therefore the required cooling loads for the tested room are found in table 4-6

Table 4-5 Glass specifications

Window type	Specifications
Single glazed aluminum frame (no thermal break)	<ul style="list-style-type: none"> • U value (Watt/ m2K)= 6.0 • Visible transmittance (0-1)= 0.753 • Admittance (Watt/ m2K)= 6.0 • Solar Heat Gain coefficient (0-1)= 0.94 • Reflective index of glass= 1.74
Double glazed low E with aluminum frame (no thermal break)	<ul style="list-style-type: none"> • emissivity = 0.10. • U value (Watt/ m2K)= 2.410 • Visible transmittance (0-1)= 0.611 • Admittance (Watt/ m2K)= 2.380 • Solar Heat Gain coefficient (0-1)= 0.75 • Reflective index of glass= 1.74

Based on the mentioned parameters, each case was tested 36 time covering all the possible approaches. Total tests of Roshan-t and Roshan-p are 318 test as explained in Table 4-6

The proposed five cases are explained in detail below and will be presented as the following:

Figure 4-13 Proposed cases legend

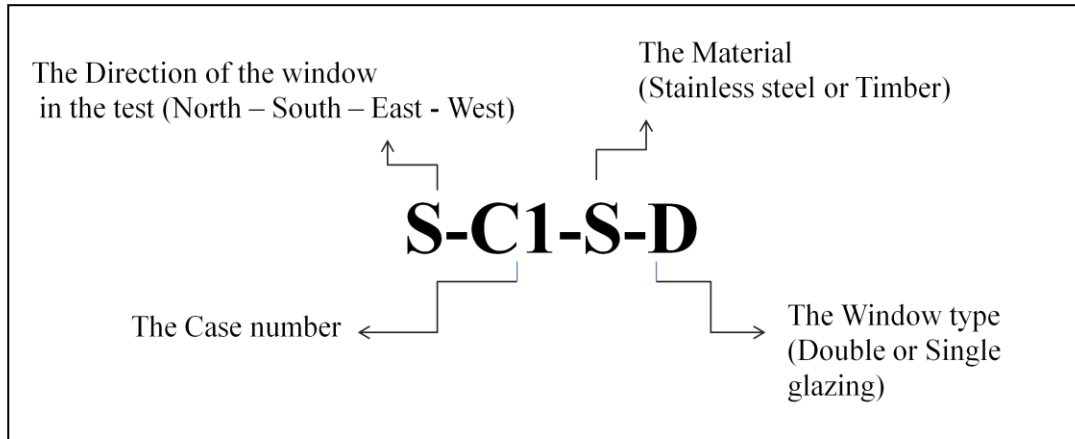

Case 1- 10cm x10cm tilted 45 degree upward openings

This case is a combination of the traditional lattice wood work or screens (i.e. 10x10 openings) and traditional, tilted wood louvers. The openings are tilted 45 degrees upwards from the interior side in order to allow light to penetrate indirectly and be reflected into the interiors. This should prove effective in providing comfortable lighting levels while avoiding direct sunlight.

In the *Roshan-t* setup, the window treatment is either tilted, wooden louvers, screens *Roshan*, or shutters as has been mentioned in chapter two, section 2.4.1 Refer to figure 2-17 and 2-19 for louver, and screens *Roshan*.

The researcher chose to combine both approaches in order to maximize the benefits and provide a modern look.

Figure 4-14 Design details of case 1 as built on Ecotect

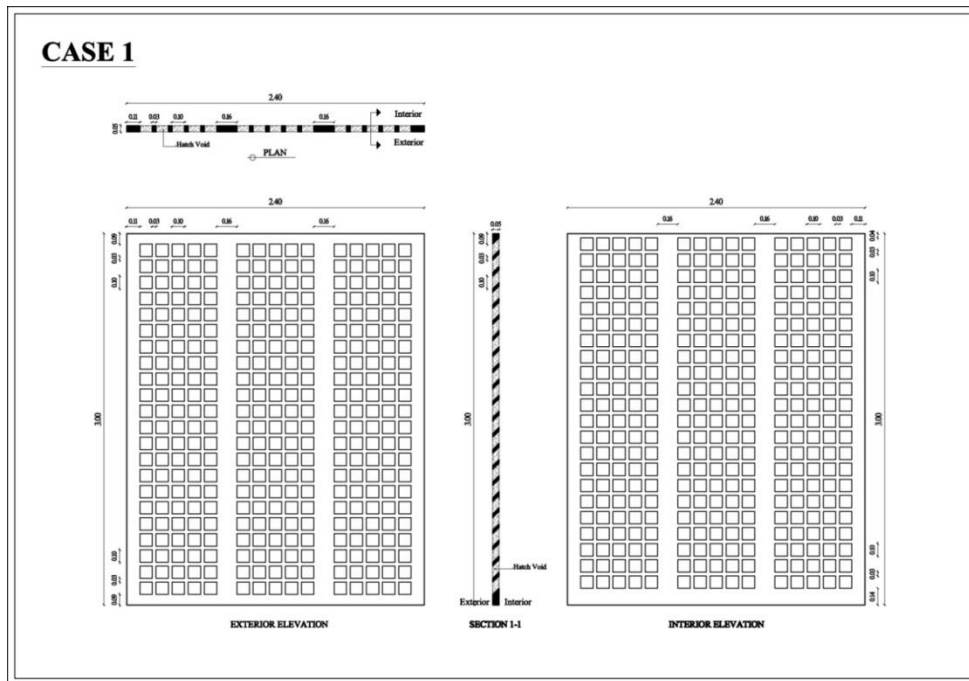
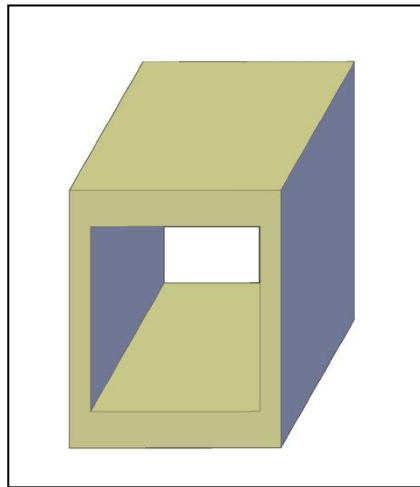

Figure 4-15 Case 1 opening blow up



The tests were conducted under the following: **S-C1-S-S** / **S-C1-S-D** / **S-C1-T-S** / **S-C1-T-D**.

The results are displayed in the table 4-7

Table 4-7 S-C1 Lux levels

Case 1									
	Lux Levels (Illuminance)								
	December			March			June		
	9 a.m.	12 p.m.	3 p.m.	9 a.m.	12 p.m.	3 p.m.	9 a.m.	12 p.m.	3 p.m.
S-C1-S-S	350	420	332	168	252	205	114	193	125
S-C1-S-D	347	396	299	151	237	189	104	187	114
S-C1-T-S	207	160	312	77	114	93	63	109	74
S-C1-T-D	198	156	290	76	112	92	62	107	73

According to the IESNA, comfortable lux levels in the living room area with the selected functions are between (50 – 500 lux) as listed in chapter two in table 2-1, for all four approaches seem to be successfully covering comfortable lux levels. Maximum lux level is 420 lux measured on December at 12 p.m. with stainless steel, single glazed approach, minimum lux level is 62 lux measured on June at 9 a.m. with the timber, double glazing approach.

Case 2 -two size openings 5cm x 5cm Exterior and 20cm x 20cm Interior

In case two, the opening from the exterior side is 5cm x 5cm and from the interior side is 20cm x 20cm. The idea is to control the daylight entering into the interior using a small exterior inlet. The light should then reflect on the sides of the opening producing secondary reflections that penetrate into the interior through the large opening.

Table 4-8 S-C2 Lux levels

Case 2									
	Lux Levels (Illuminance)								
	December			March			June		
	9 a.m.	12 p.m.	3 p.m.	9 a.m.	12 p.m.	3 p.m.	9 a.m.	12 p.m.	3 p.m.
S-C1-S-S	28	34	27	15	25	20	7	12	7
S-C1-S-D	420	26	20	12	18	15	6	10	6
S-C1-T-S	14	19	16	8	13	10	5	9	6
S-C1-T-D	11	14	12	6	9	8	4	7	5

The overall lux level results seems to be very low, minimum reading was 4 lux and maximum was 34 lux except for stainless steel, double glazing at 9 am it was 420 lux which is considered to be on a higher scale comparing to the rest of the readings. Therefore the researcher decided to attempt the opposite approach, with the large opening from the exterior and the small opening from the interior, in hopes that it might produce better lux levels.

Case 3 -two size openings 20cm x 20cm Exterior and 5cm x 5cm Interior

Case three is the opposite of case two, where there is a 20cm x 20cm opening from the exterior side and a 5cm x5cm opening from the interior side. This design approach was taken after case two had low lux level results.

Figure 4-18 Design Details of Case 3 as built on Ecotect

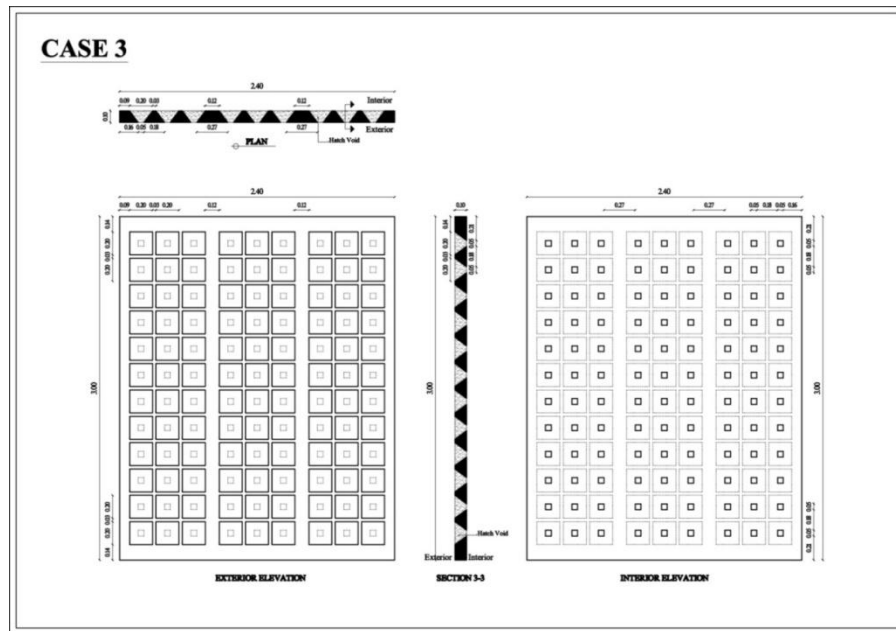
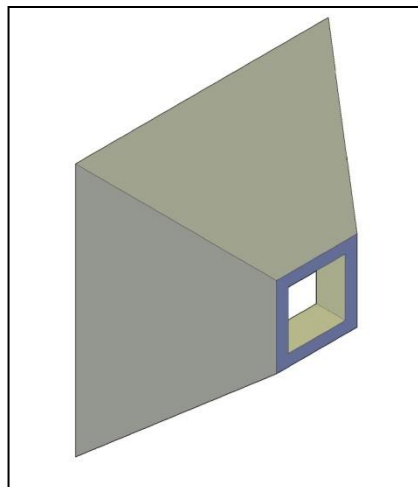

Figure 4-19 Case 3 opening blow up



The tests were conducted under the following: **C3-S-S** / **C3-S-D** / **C3-T-S** / **C3-T-D** and the results are displayed in the table 4-9

Table 4-9 S-C3 Lux levels

Case 3 (2 size openings 5x5cm Exterior/ 20x20cm Interior)									
	Lux Levels (Illuminance)								
	December			March			June		
	9 a.m.	12 p.m.	3 p.m.	9 a.m.	12 p.m.	3 p.m.	9 a.m.	12 p.m.	3 p.m.
S-C1-S-S	x	71	x	x	4	x	x	3	x
S-C1-S-D	x	69	x	x	3	x	x	3	x
S-C1-T-S	x	89	x	x	4	x	x	4	x
S-C1-T-D	x	69	x	x	3	x	x	3	x

In case 3 when the researcher started calculating the lux levels, it was obvious from the first couple of tests that the lux levels were very low. Therefore, for the sake of research time, the tests were only conducted in the peak time which is according to previous cases the highest lux levels were at 12 p.m., and they were conducted throughout the three seasons, and over the four approaches. In all, the results of lux levels are very low in case 3, and the rest of the tests at 9 a.m. and 3 a.m. through the three season and over the four approaches were ignored for the invalidity of this approach.

Case 4- two size openings 20cm x20cm with 90 degree Exterior / 15cm x 15cm with 45 degree Interior

From the above cases, the researcher concluded that the sides of the openings are playing a major effect on daylight penetration into the room, and the 10cm x 10cm opening seems to be slightly small to allow enough light penetration for comfortable lux levels. More options of shape openings were explored for case four, where the openings were enlarged to 20cm x20cm for the exterior opening with a 90 degree angle. The sides of the opening were rotated to make a 15cm x15cm opening at a 45 degree angle from the interior side. The aim of conducting the rotated shape of openings, is to create many angles inside the opening surface, where the light should be diffused then penetrated into the interior.

Table 4-10 S-C4 Lux levels

Case 4									
	Lux Levels (Illuminance)								
	December			March			June		
	9 a.m.	12 p.m.	3 p.m.	9 a.m.	12 p.m.	3 p.m.	9 a.m.	12 p.m.	3 p.m.
S-C1-S-S	822	1660	1324	135	577	324	104	200	116
S-C1-S-D	636	1288	997	107	444	249	82	158	88
S-C1-T-S	806	1631	1287	119	546	295	94	183	118
S-C1-T-D	619	1257	995	93	422	225	76	143	48

Higher lux levels were achieved when compared to case two and three, in December readings all the tests were higher than the comfort level. Thus in March and June most of the readings were within the desirable range.

Table 4-11 S-C5 Lux levels

Case 5									
	Lux Levels (Illuminance)								
	December			March			June		
	9 a.m.	12 p.m.	3 p.m.	9 a.m.	12 p.m.	3 p.m.	9 a.m.	12 p.m.	3 p.m.
S-C1-S-S	1134	1793	1280	259	835	290	125	243	136
S-C1-S-D	874	1400	988	201	629	225	99	187	107
S-C1-T-S	529	924	706	92	324	158	54	106	60
S-C1-T-D	409	718	549	71	246	124	44	83	48

The results are close to case four where, in general, the lux levels seem to be reasonable although some calculations are higher than the comfort level, especially in December.

General conclusion when comparing the five cases excluding case number three, almost in all cases the highest reading when comparing the approaches by season was at 12 p.m. on the single glazing, with stainless steel material. And the highest of all was always on December. While the lowest reading of lux level was always at 9 a.m. in the double glazing with timber material approach and the lowest reading of all seasons was always in June.

That determines that the material property has a major affect on the reflection of light, where stainless steel can reflect more light into the space and the timber absorbs the light and reduces the light reflection.

4.2.3 Step Three: Development of the successful case

As mentioned earlier in the research plan, the most successful case in terms of achieving desirable lux levels will be tested over the other three directions, during the three selected seasons, and three times a day.

From the above results, case one presented the best lux levels as all tests fell within a comfortable, desirable light range although cases 4 and 5 seem to have reasonable potential of achieving comfortable lux levels if more tests and manipulations were performed.

Table 4-12 S-C1 Sum of Lux levels

Case 1										
	Lux Levels (Illuminance)									Sum of each approach
	December			March			June			
	9 a.m.	12 p.m.	3 p.m.	9 a.m.	12 p.m.	3 p.m.	9 a.m.	12 p.m.	3 p.m.	
S-C1-S-S	1134	1793	1280	259	835	290	125	243	136	2159
S-C1-S-D	874	1400	988	201	629	225	99	187	107	2024
S-C1-T-S	529	924	706	92	324	158	54	106	60	1209
S-C1-T-D	409	718	549	71	246	124	44	83	48	1166

When adding the sum of each approach, the instances in which stainless steel sides were used produced the best lighting lux levels. In addition, the approach using windows with single glazing had higher lux levels. However, since this study is also concerned with the cooling loads as well, cooling loads for both approaches will be tested to assure that the best solution scored the highest lux levels possible within the desirable range and the lowest cooling demands.

Cooling loads were conducted for both approaches as shown in the table below:

Table 4-13 S-C1 Cooling loads

	South	North	East	West	TOTAL
S-C1-S-D	101,700	99,468	100,656	101,052	402,876
S-C1-S-S	103,608	100,584	109,620	102,816	416,628

It is obvious from the above table that the cooling loads in the southern direction for case one, utilizing stainless steel material for the sides and a double- glazed, low E aluminum-framed window were lower than the cooling loads for the windows with single glazing. Therefore, the lux calculation for **C1-S-D** will be tested on the other three directions (i.e. north, east, and west.)

Table 4-14 C1 Lux levels over three orientations (North/ East/ West)

Case 1									
	Lux Levels (Illuminance)								
	December			March			June		
	9 a.m.	12 p.m.	3 p.m.	9 a.m.	12 p.m.	3 p.m.	9 a.m.	12 p.m.	3 p.m.
N-C1-S-D	67	102	83	90	126	111	147	198	164
E-C1-S-D	799	132	82	756	169	107	589	204	115
W-C1-S-D	66	112	456	88	138	347	102	183	320

In the table above, the eastern direction at 9 a.m. is receiving higher lux levels than expected and this will be discussed in chapter five.

4.2.4 Step Four

As was mentioned earlier in the research plan, the lux levels and the cooling load of the selected case will be compared with the traditional setup results, this section will be discussed in Chapter Five for further discussion and analysis.

4.3 Conclusion

In this chapter the process of conducting the four steps of the research plan was explained in details, in step one *Roshan-t* was built and tested though four orientations, three seasons a year, and three times a day, the worst orientation in terms of excessive lux levels was selected to be

the south orientation based on achieving the highest results in terms of the sum of lux levels of the mentioned orientation and on the indirect solar gain tests. In step two five *Roshan-p* cases were proposed, and tested over the south orientation, case 1 with the use of stainless steel material was selected to have best outcome of all approaches. In step three the successful case (case 1) was tested over the other three orientations, north, east, and west, to assure that it is a good solution as a shading device, but seems the eastern orientation at 9 a.m. only is exceeding the comfortable level. Further discussion and analysis will take place in chapter five. In step four cooling loads will be calculated for *Roshan-t* and *Roshan-p* case one for comparison and analysis and will be discussed in chapter five.

Chapter Five: Conclusion and Recommendation

5.1 Introduction

The aims and objectives of this research, as stated earlier in chapter one, were to develop a shading device to be utilized in modern houses in the Saudi Arabian city of Jeddah with the intention of providing the physically desirable amount of natural lighting and at the same time socially accepted visual privacy.

The objectives of the research were as follows:

1. To explore and identify the current situation of Hejazi residential buildings in terms of natural lighting and visual privacy.
2. To understand, through a literature review, the *Roshan* as an architectural environmental regulatory device used in Hejazi architecture.
3. To explore a natural-lighting control device that is inspired by the *Roshan* and designed using a parametric methodology.
4. To carry out a computer-simulated experiment in order to compare the *Roshan-t* device and the developed *Roshan-p* device in an attempt to validate the latter.

In this chapter the researcher will fulfill the main objectives of the research, discuss the results, and analyze the findings for further studies and recommendations, starting with the main objective of the research which is providing efficient natural lighting to contemporary architecture in Jeddah, through literature review it was found out that the *Roshan* proved to be a sustainable shading device of its time, therefore the researcher decided to adopt the *Roshan* to be a reference for the proposed modern shading device. Followed the researcher investigates in the efficiency of the proposed shading device which covers two main subjects; providing comfortable natural lighting and efficient consumption of energy in terms of cooling loads. Finally the researcher analyzes the findings and proposes recommendations for further studies.

5.2 Efficient Natural Lighting Inspired by Tradition

It was presented in chapter two, section 2.2, the importance of the availability of natural-lighting in the living spaces of human beings was presented as a basic functional requirement for both physical and psychological wellbeing.

Through historical documentation, it was shown how Hejazi houses were influenced by many cultures throughout their history due to its strategic location as a trade center between three continents and a central traveling point for Muslims on pilgrimage to Makkah. The traditional architecture of these houses displayed an impressive understanding of human needs in terms of natural-lighting availability as well as the social and religious needs of privacy. These factors helped to identify the *Roshan* design as a comprehensive solution.

Globalization has had an impact on the modern architecture in Saudi Arabia, in general, and in Jeddah specifically. The result left Jeddah with building designs that pay no respect to the location, climate or social needs.

Developing a modern shading device that is inspired by *Roshan* was the main objective of this research. By studying the performance of the traditional *Roshan* through parametric research, the researcher was able to identify a number of solutions for shading devices.

One design case was more successful in providing comfortable natural lighting levels than the others; nevertheless, some of the other cases have a relatively high chance of achieving good, natural-lighting attributes. Further details will be explained in the next section.

5.2.1 The Design of the shading device and its Efficiency

When talking about the performance of an efficient shading device, two aspects need to be considered: the natural-light penetration though the device and the impact of the device on energy consumption. The goal of this research was to implement a measured balance between these two aspects.

5.2.1.1 Natural lighting

An evaluation of natural lighting in traditionally designed houses using *Roshan* as a shading device showed that *Roshan* provided a reasonable balance of natural-lighting penetration and shading. In the past, people relied on shading and natural ventilation for passive-cooling strategies. The lux levels in the tested room in general were reasonable, especially when the

window orientating was set to the north with a minimum reading of 200 lux and maximum reading of 629 lux. On the other hand, when set to the south, window orientation proved to be the least desirable orientation for buildings in Jeddah. The minimum value was 324 lux while the maximum was 5,409 lux at 12 p.m. in December (the highest readings of all directions). One explanation for this result is the low position of the sun in December as it is titled 23° towards the south and the vertically centralized position of the sun at 12 p.m. on the building . Results for the east and west were fairly reasonable with an average lux level of 442. An exception was in the east during the early morning where values can reach up to 4,651 lux as well as in the west in the late afternoon where values can reach up to 3,616 lux.

In the five proposed modern cases, when using stainless steel material in the shading device, nearly all cases read higher lux levels than using timber. This is of course due to the nature of the material properties themselves. Stainless steel is a highly reflective material while timber is rough and absorbs light more. Also, in most cases where single glazing was used, the lux levels were higher than when using double glazing with low-E coating. This is due to the treatment the glass receives when coated with low-E film.

It could be concluded that using a highly reflective material will reflect more light into the space, but then the opening size should be reduced and the glass type should have higher specifications against heat transmission, to reduce the interior heat gain.

As for case one, where the 10cm x 10cm openings were tilted 45° upward on the interior side, all the lux readings were within the comfortable range of 50 to 500 lux. Therefore, this case was selected as the best solution. Nevertheless, when testing other orientations, higher readings occurred at 9 a.m. when the window was oriented toward the east. The researcher is aware of the critical nature of the east, but based on the indirect solar gain and the excessive lux levels, the south proved to be the worst. When these results were analyzed the outcomes explains that the east orientation receives higher lux levels but the west orientation receives higher heat gain. Nevertheless, more investigation should be conducted to solve the issue of high lux levels for the east. Due to the limitations of this research, and for the sake of time, future researchers are encouraged to investigate more in this area.

For cases two and three, the opening sizes were 20cm x 20cm and 5cm x 5cm. In case two, the small opening was on the exterior side while the large opening was on the interior side. In case three, the large opening was on the exterior side and the small opening was on the interior side. While case two produced better results, the overall lux levels readings were very low for both cases with a minimum lux level of 3 lux and the maximum of 89 lux. Based on the tests results the approach of the case two seems to have an opportunity of success if was manipulated more to reach the correct balance. Controlling the inlet of the light source form the exterior side to be smaller than the inlet from the interior side, and using high reflective material on the sides of the opening, where the controlled entering direct sunlight will be reflected by the high reflective material into the interior space. This approach is maximizing the light reflection, and minimizing the glazed area therefore it is minimizing the heat gain.

For cases four and five, after learning from cases two and three, the researcher decided to enlarge the opening sizes and rotate the square opening. For case four, the rotation was from 90° on the exterior to 45° on the interior side. In case five, the opening was rotated from 45° on the exterior side to 90° on the interior side.

In both cases, lighting lux levels were within the comfortable range in March and June, except at 12 p.m. in March for the single-glazing window approaches. In addition, all readings in December were higher than the comfortable level.

The results of cases four and five may prove positive if further developed and investigated in order to solve the issue of a low positioning of the sun in December. Correcting this issue should yield better results. Again the concept of this approach is to diffuse the natural lighting entering from the opening by reaching a surface that is three dimensionally rotated, therefore the light entering the room will have multiple reflections until it reaches the interior space. If the December sun position seems to be the problem in this approach, changing the angle of the opening might be a good solution to avoid the direct sun light, meaning the opening itself to be tilted upward into the interior side. The material property should be chosen carefully to avoid reflecting excessive amount of natural lighting.

When comparing the lux levels of the traditional setup with the proposed approach, there is a large difference in the findings as shown in graph in figure

Figure 5-1 *Roshan-t* Lux levels over four orientation (North/ East/ West/ South)

Traditional Setup										
	Lux Levels (Illuminance)									Lux sum up
	December			March			June			
	9 a.m.	12 p.m.	3 p.m.	9 a.m.	12 p.m.	3 p.m.	9 a.m.	12 p.m.	3 p.m.	
N-Traditional	200	284	236	286	342	318	318	629	498	3,111
E-Traditional	3606	451	237	4,651	544	292	4,034	686	303	14,804
W-Traditional	198	368	2,784	248	389	3,616	275	587	2,756	11,221
S-Traditional	3,464	5,409	2,859	600	1,512	327	324	566	358	15,419

Table 5-1 A comparison of *Roshan-t* Lux levels over four orientation (North/ East/ West/ South)

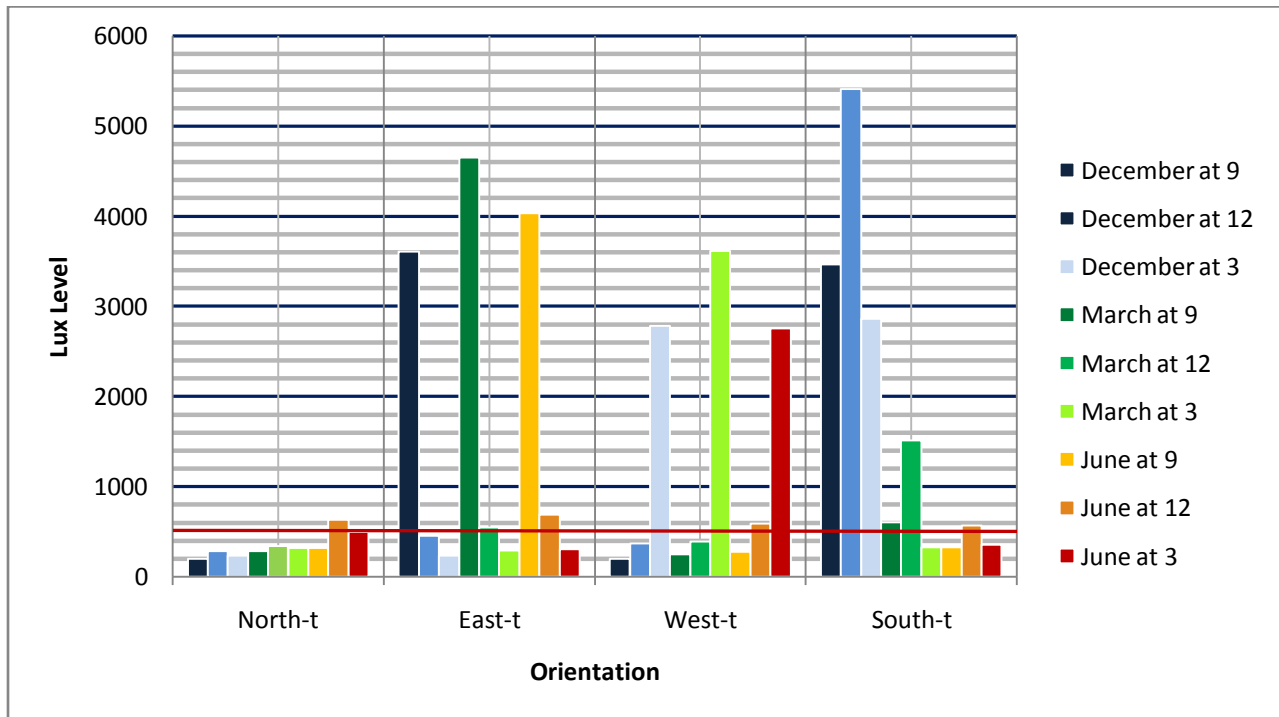
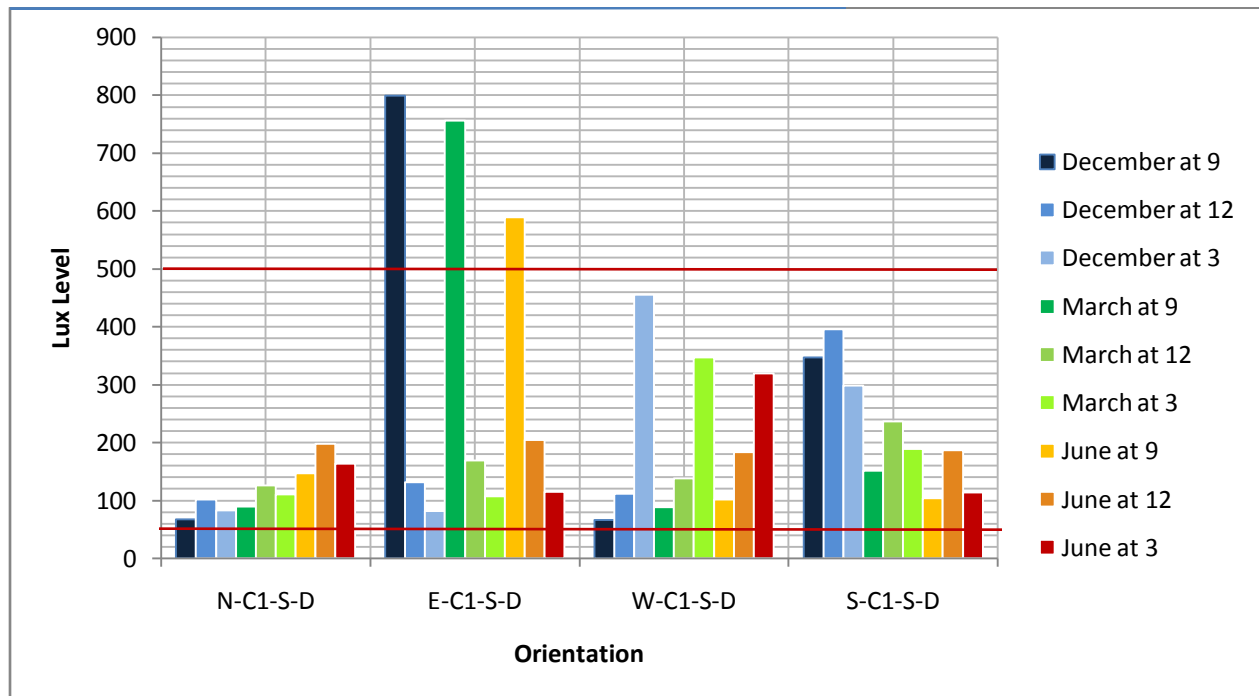

Figure 5-2 Case one Stainless steel double glazed low E aluminum frame lux levels over four orientations.

Case 1										
	Lux Levels (Illuminance)									Lux sum up
	December			March			June			
	9 a.m.	12 p.m.	3 p.m.	9 a.m.	12 p.m.	3 p.m.	9 a.m.	12 p.m.	3 p.m.	
N-C1-S-D	67	102	83	90	126	111	147	198	164	1,088
E-C1-S-D	799	132	82	756	169	107	589	204	115	2,953
W-C1-S-D	66	112	456	88	138	347	102	183	320	1,812
S-C1-S-D	347	396	299	151	237	189	104	187	114	2,024

Table 5-2 A comparison of case one stainless steel double glazed low E aluminum frame lux levels over four orientations.



This approach was able to produce lux levels in the comfortable range between (50-500 lux) by introducing a more developed shading device that includes double-window glazing with low-E coating. Also, it is worth mentioning that when comparing the traditional setup with the selected approach, the worst reading in the traditional setup was for the southern direction while in the selected approach it was the east direction. This may show that the excessive lux levels for the south were reduced by introducing the new approach, thereby producing higher lux readings for the east. As mentioned earlier in this section, high lux levels in the selected approach are only in the east during the morning time.

It is also worth mentioning, although the eastern orientation had higher lux levels, the western orientation had higher heat gain, (refer to figure 5-2 and table 5-1 for comparison). That can be explained with the characteristics of the daylight that each orientation receive. The daylight properties of the morning time from sun rise till 12 p.m. noon time in the eastern orientation does not match the properties of the daylight that the western orientation receives from 12 p.m. till sunset. The morning daylight is known to be healthier and cooler, where the afternoon daylight is characterized to be warmer. That explains even if the lux levels are high over an orientation, it is not necessary the heat gain will be the highest over that orientation. The orientation, and the time of the day are the main factors that determine the heat gain received.

This might indicate that since each orientation has its own characteristics, then each orientation should have a different solution that can overcome the its problems. As the proposed shading device of case one, was able to solve the direct sunlight in the south direction, by openings that were tilted 45° upward on the interior side, other approaches for the east and west directions separately should have to be developed to overcome characteristics of the mentioned orientations.

As a recommendation the researcher will advice to orient the residential building in Jeddah towards the north direction as it was proven to be the best in receiving reasonable amount of natural lighting, considerably amount of heat gain, and the best wind direction and speed from the north, and northern west. since the researcher is aware that it is impossible to orient all buildings toward the northern direction, therefore with the use of the proposed shading device the southern and western will be a safe orientation to direct the building towards, as for the eastern side other considerations can be taking into account during early morning hours where

the problem occurs. For example movable angle of openings which can avoid the direct sunlight. This is an area requiring further investigation..

Based on the information mentioned in the literature review in chapter two, section 2.2.3.2, the *Roshan*, when used as a shading device, provided the desired privacy for family houses. Using a more developed shading device based on *Roshan-t* should provide the same desired privacy if not even more when using tilted openings. The Ecotect and Radiance programs are not able to provide testing of visual privacy. Therefore, further investigation into other software programs in order to test the visual privacy level is encouraged for future investigation.

5.3 Energy efficiency

As has been explained in the literature review in chapter two, section 2.2.3, this research is concerned with decreasing the energy consumption required for cooling the 36m² test room. Therefore the cooling loads (watts per hour) of the tested room using the *Roshan-t* device was calculated and compared with the tested room using the *Roshan-p* device. The results for case one in **S-C1-S-D**, and **S-C1-S-S** are shown in table below.

Table 5-3 Cooling load required in Watt per hour for the 36m² tested room

	South	North	East	West
Traditional	208,368	206,424	205,668	207,576
S-C1-S-S	103,608	100,584	102,096	102,816
S-C1-S-D	101,700	99,468	100,656	101,052

Figure 5-4 Reduction of cooling load in percentage

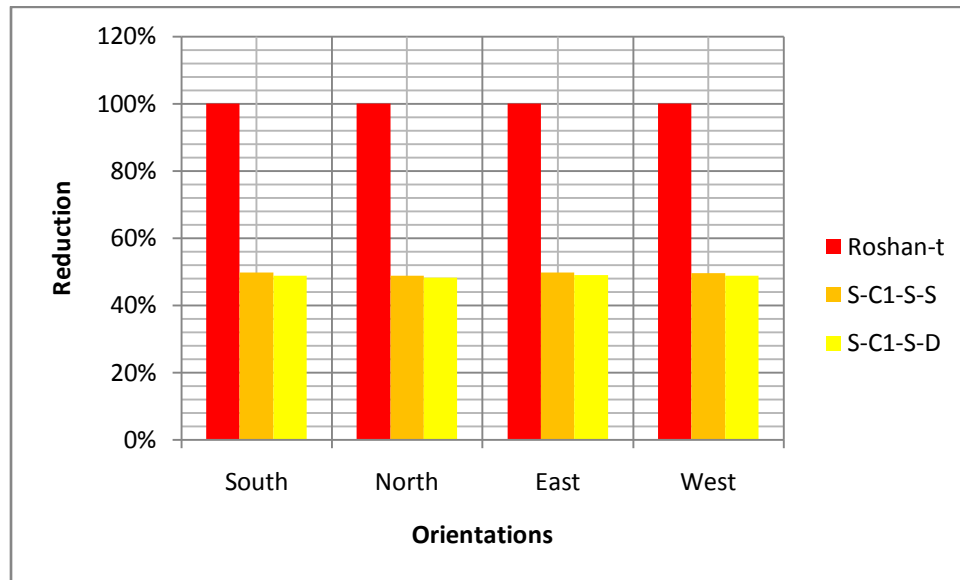

All readings using the *Roshan-p* with double-glazed, low-E aluminum framing are lower than both the single-glazed framing and the *Roshan-t*. In addition, the cooling loads of the *Roshan-p* with single-glazed aluminum framing were lower than those of the *Roshan-t*. This means that the cooling loads of the tested room with the use of the *Roshan-p* and single-glazing have been reduced to about 50% of the total loads when compared to the *Roshan-t*. Thus, when comparing the cooling loads for single-glazed frames with those of double-glazed frames, both with low E, the load was reduced to between 1-2% of the total consumption.

The difference between the cooling loads of a single-glazed and double-glazed low E aluminum frame for the proposed shading device is quite low. The researcher decided to investigate the reason behind the poor decrease in cooling loads between the two types of glass as mentioned in chapter four section 4.2.2

According to Chow and Lin in a research paper published in 2010, and entitled, “Innovative Solar Windows for Cooling-Demand Climate,” reflective glass was seen as the most heat-gaining, reduction-type glass that can be used in windows. The two major factors that affect the performance of reflective glass are the solar heat gain coefficient, which indicates the thickness and reflectivity of the coating, and the visible transmittance. “The reflective coating usually

consisted of thin metallic or metal oxide layers and comes in various metallic colors such as bronze, silver, or gold” (Chow and Lin 2010, p. 214).

Table 5-4 shows different glass specifications for the windows used in the Ecotect calculations for this research and the glass types mentioned in the Show and Lin research paper. Single clear glass represents the basic glass type used in windows. Low-E and reflective on clear glass types represent the most efficient window glass type in terms of heat gain reduction in this specific region of the world.

Table 5-5 Glass types specifications, Chow and Lin (2010)

	Glass Type	U-Value (W/m ²)	Visible transmittance	Admittance (W/m ²)	Solar Heat Gain coefficient (0-1)	Reflective index of glass	Room heat gain (W/m ²)
Ecotect	Single glazed aluminum frame	0.6	0.753	0.6	0.94	1.74	
	Double glazed low E aluminum frame	2.41	0.611	2.38	0.75	1.74	
Chow and Lin	Single clear glass	6.01	0.888		0.777		465
	Low-E and reflective on clear glass	2.423	0.305		0.341		134

As shown in table 5-5, the visible transmittance and the SHGC of the double-glazed low-E aluminum frame window used in the Ecotect calculations is high compared to the low-E and reflective glass types. The result is similar to the single-glazed aluminum frame. That explains the insufficient differences between the cooling-load demands of the single and double-glazed, low-E types of proposed *Roshan-p*.

5.4 Conclusion

This research has basically initiated seeking for a sustainable shading solution for the *Hejazi* contemporary houses of Jeddah. aiming to fulfill the society physical, cultural, religious needs. The researcher has identified through literature review that the *Roshan* in traditional *Hejazi* architecture was an excellent example of a form that complements its function while utilizing the surrounding environment. Saying that a proposed approaches of a contemporary shading device inspired by the traditional *Roshan* was developed and tested for the ultimate solution. The researcher explored a number of previously adopted investigation methodologies, based on the given analysis, and the research approach, computer simulations as an investigation method was conducted. Findings of the research was presented and analyzed and a final conclusion will be summarized in terms of the efficiency of the shading device. In terms of natural lighting efficiency the proposed approaches of the shading device was compared with the *Roshan-t* and the comfortable natural lighting standards mentioned earlier in the literature review. Natural lighting findings of *Roshan-t* seems to be reasonably comfortable when the *Roshan* is oriented towards the north, while south orientation gave the worst readings of excessive lighting, east and west orientations gave excessive lighting results at certain amount of the day. Natural lighting findings of *Roshan-p* was always affected by the orientation, material and glazing type. Among the five proposed approaches case 1 was selected as the most successful, nevertheless case 2,4,and 5 were found to have positive potential if further developed.

Case 1 (10cm x10 cm opening tilted 45° upward on the interior side) with the use of stainless steel material and double glazing low E aluminum frame proven to be the best proposed solution over the three orientation (North, south, and west). Nevertheless most of the east orientation time reasonable lux levels were achieve accept during the morning time, due to the low position of the sun during that time.

In terms of energy efficiency the case 1 (10cm x10 cm opening tilted 45° upward on the interior side) with the use of single glazing window succeeded in reducing cooling loads up to 49% from *Roshan-t* setup. With the use of double glazing low E aluminum frame only 1-2 % was reduce comparing to the single glazing. More investigation in the tested glazing specifications was conducted, finding that reflective window glazing with low E seems to have better visible

transmittance and the SHGC properties that will give better energy efficiency results, and this is a recommended subject to be investigated further in future research.

5.5 Recommendations

- 1- The researcher was able to solve the problem of excessive lux levels using the proposed shading device over three orientations (i.e. north, south, and west). Further investigation should be conducted to solve the problem of high lux levels during the morning time for the east orientation.
- 2- In case four, with two size openings at 45/90, and case five, with two size openings at 90/45, more investigation is needed to solve the problem of the sun's low position in December. That should provide better results.
- 3- More glass types with different specifications should be investigated.
- 4- A method for measuring privacy levels when using *Roshan* type shading devices should also be investigated.

References

- Albrahim, M., 2001. *Shelter in Saudi Arabia*. Translated from the English, by Talib, K. Academy Editions. (Originally published in 1984)
- Al-Jofi, E. K. E., 1995. *Effect of The Rawshan on The Provision of Daylight for The Shopping Precincts*. Thesis (PhD) University of Wales.
- Al-Shareef, F. M., 1996. *Natural light Control in Hedjazi Architecture: An Investigation of the Roshan Performance by Computer Simulation*. Thesis (PhD) University of Liverpool.
- Al-Shareef, F.M., Oldham, D.J., & Carter, D.J.,2000. A computer model for predicting the daylight performance of complex parallel shading systems. *Building and Environment*, 36 (2001), 605-618. Available from: www.sciencedirect.com. [Accessed 4 February 2010].
- Baker, N., Fanchiotti, A. and Steemers, K., 2001. *Daylighting in architecture*. Third edition. London: James and James (Science publishers) Ltd.
- Baker, N. and Steemers, K., 2002. *Daylight design of buildings*. London: James and James (Science publishers) Ltd.
- Cheung, H. D. and Chung,T. M., 2008. A study on subjective preference to daylit residential indoor environment using conjoint analysis. *Building and Environment*, 43 (2008), 2101–2111. Available from: www.sciencedirect.com. [Accessed 22 January 2010].

Chown, T. and Li, C., and Lin. Z., 2010. Innovative solar windows for cooling-demand climate. *Solar Energy Materials & Solar Cells* 94 (2010), 212–220. Available from: www.sciencedirect.com. [Accessed 23 April 2010].

Eben Saleh, M. A., 1997. Privacy and communal socialization: the role of space in the security of traditional and contemporary neighborhoods in Saudi Arabia. *Habitat Intel*, 21 (2), 167-184. Available from: www.sciencedirect.com. [Accessed 22 January 2010].

El-Hege, B., 1997. [*Saudi Arabia: Caught in Time 1861-1939*]. United Kingdom: Garnet Publishing Ltd. (in Arabic)

Galasiu, A. D., Laouadi, A., Armstrong, M. M., Swinton, M. C., and Szadkowski, F., 2009. Field summer performance of interior reflective screen shades for residential windows. Ed. The 11th international building performance simulation association, 27-30 July 2009 Glasgow Scotland: University of Strathclyde in Glasgow, 1-10.

Germeraad, P.W., 1992. Islamic tradition and Contemporary Open Space Design in Arab-Muslim settlements in the Middle East. *Landscape and Urban Planning*, 23 (1993), 97-106. Available from: www.sciencedirect.com. [Accessed 22 January 2010].

Greenlaw, J. P., 1976. *The coral buildings of Suakin*. Northumberland: Oriel Press Ltd. (Routledge & Kegan Paul Ltd.)

Greenup, P., Bell, J.M., & Moore, I., 2001. The importance of interior daylight distribution in buildings on overall energy performance. *Renewable Energy*, 22 (2001), 45-52. Available from: www.sciencedirect.com. [Accessed 20 February 2010].

Groat, L. and Wang, D., 2002. *Architectural research methods*. Canada: John Wiley and sons, Inc.

Hammad, F. T., 2010. *An evaluation study of external dynamic louvers in office building in Abu Dhabi*. Dissertation (MSc) The British University in Dubai.

Hariri, M. M., 1989. [*Design guidelines of Residential buildings in Islamic architecture*]. Saudi Arabia: Hariri.(in Arabic)

Hariri, M. M., 1991. [*The courtyard and looking to the sky*]. Saudi Arabia: Hariri.(in Arabic)

Hariri, M. M., 1991. Roshan Design and importance for houses. *Om al Quraa University Magazine*, 5 (3), 181-219.(in Arabic)

Hazmi, O., Al-Ghamdi, O., Al-Maimani, E., Ghandoura, M., Khafaji, M., Marghalani, M. (2007) 'Al Roshan', *shafei House*, King Abdul Azizi University: Architectural Department, 24, illus.

Hviid, C. A., Nielsen, T. R., and Svendsen, S., 2008. Simple tool to evaluate the impact of daylight on building energy consumption. *Solar Energy* 82 (2008), 787–798. Available from: www.sciencedirect.com. [Accessed 23 April 2010].

Ip, K., Lam, M., Miller, A., 2009. Shading performance of a vertical deciduous climbing plant canopy. *Journal of Building and Environment* 45 (2010), 81–88. Available from: www.sciencedirect.com. [Accessed 23 April 2010].

Jeddah municipality. 2010., *About Jeddah: Jeddah history*. Available at: <http://www.jeddah.gov.sa/english/jeddah/history.php>. [Accessed:17 March 2010].

Jelsoft Enterprises Ltd (2007) *1917, 1916 - British consulate* [image online], available: <http://www.skyscrapercity.com/showthread.php?t=489776> [accessed 14 June 2010]

Jomah, H. A. S., 1992. *The Traditional Process of Producing A House in Arabia During The 18th and 19th Centuries: A Case-Study of Hedjaz*. Thesis (PhD) University of Edinburgh.

Kim, G. and Kim, J. T., 2010. Healthy daylighting design for the living environment in apartments in Korea. *Journal Building and Environment*, 45 (2010) 287-294. Available from: www.sciencedirect.com. [Accessed 22 January 2010].

King, G., 1998. *The traditional architecture of Saudi Arabia*. London: I.B. Tauris publishers.

Li, D. and Tsang, E., 2005. An analysis of measured and simulated daylight illuminance and lighting saving in daylit corridor. *Journal of Building and Environment* 40 (2005), 973-982. Available from: www.sciencedirect.com. [Accessed 18 February 2010].

Radiance synthetic imaging system, 2002. *What is Radiance?*. Radiance synthetic imaging system. Available from: <http://radsite.lbl.gov/radiance/> [accessed 8 May 2010]

Reinhart, C., & Fitz, A., 2006. Findings from a survey on the current use of daylight simulations in building design. *Energy and Buildings*, 38 (2006), 824-835. Available from: www.sciencedirect.com. [Accessed 18 February 2010].

Rea, M. S. (2000) 'Recommended reflectances for interior surfaces of residences', *The IESNA Lighting Handbook Reference and Application*. New York: IESNA Publication Department, 18-2, Figure.

Shaheen, A., 2006. *An ICT Approach towards the Developments of an Environmentally Responsive Architectural Education*. Thesis (PhD) Architectural Association Graduate School of Architecture.

Tavares, S. G., & Silva, H. D., 2008. Daylight simulation in buildings, ed. *25th conference on passive and low energy architecture*, 22-24 October 2008 Dublin.

Tzempelikos, A., 2008 The impact of venetian blind geometry and tilt angle on view, direct light transmission and interior illuminance. *Solar Energy* 82 (2008) 1172–1191. Available from: www.sciencedirect.com. [Accessed 23 April 2010].

University of Strathclyde Glasgow, *Day lighting Design Factors*. Scotland, University of Strathclyde Glasgow. Available from: (<http://www.esru.strath.ac.uk/Courseware/Class-design/lighting/light-des-2.htm>) [accessed 8 May 2010]

Wikipedia the free Encyclopedia, 2010. *Autodesk Ecotect Analysis*. Wikipedia. Available from: http://en.wikipedia.org/wiki/Autodesk_Ecotect_Analysis [accessed 7 May 2010]

Wikipedia the free Encyclopedia, 2010. *Radiance Software*. Wikipedia. Available from: [http://en.wikipedia.org/wiki/Radiance_\(software\)](http://en.wikipedia.org/wiki/Radiance_(software)) [accessed 8 May 2010]

Winchip, S., 2005. *Lighting environment*. New York: Fairchild Publications, inc.

Wzira, Y.(1999) 'Inspirational detail of Saudi Roshan' , *The Encyclopedia of the Islamic architectural elements*, Egypt: Madbooli book store, 109, illus (in Arabic)